

O P E R A T I N G I N F O R M A T I O N

# 8672A

## SYNTHESIZED SIGNAL GENERATOR

DUPLICATE OF SECTIONS 1 THRU 3  
OF YOUR OPERATING AND SERVICE MANUAL  
KEEP WITH INSTRUMENT

Printed: JUNE 1980  
© Hewlett-Packard Co. 1977, 1978, 1980



MODEL 8672A

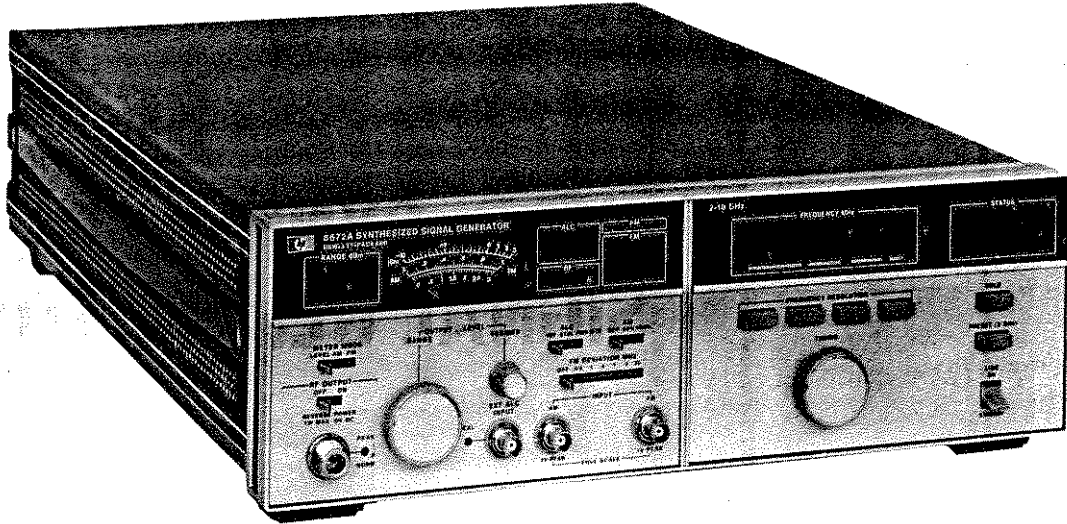

EXTENDER BOARDS

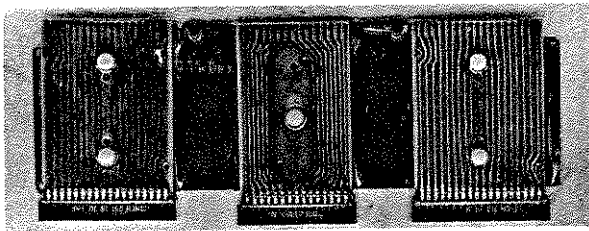

LINE POWER CABLE

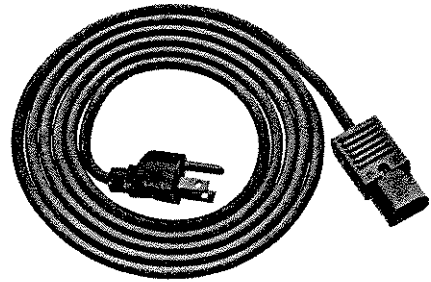

FUSE



NOTE: See ACCESSORIES SUPPLIED in Section I for more details.

Figure 1-1. HP Model 8672A and Accessories Supplied.

## SECTION I

### GENERAL INFORMATION

#### 1-1. INTRODUCTION

1-2. This manual contains information pertinent to installation, operation, testing, adjusting, and servicing the Hewlett-Packard Model 8672A Synthesized Signal Generator. The Model 8672A will generally be referred to as the Synthesizer throughout this manual.

1-3. Information pertaining to the Hewlett-Packard Interface Bus (HP-IB) as it relates to the Synthesizer is found in various sections of this manual. Section VIII contains a diagnostic program for checkout of HP-IB functions. A remote operator's check is also found in Section VIII.

1-4. Figure 1-1 shows the Synthesizer with all supplied accessories.

1-5. Packaged with this manual is an Operating Information Supplement. This is simply a copy of the first three sections of this manual. This supplement should stay with the instrument for use by the operator. Additional copies may be ordered separately through your nearest Hewlett-Packard office. The part number is listed on the title page of this manual.

1-6. On the title page of this manual, below the manual part number, is a "Microfiche" part number. This number may be used to order 100 x 150 mm (4 x 6-inch) microfilm transparencies of the manual. Each microfiche contains up to 96 photo-duplicates of the manual pages. The microfiche package also includes the latest Manual Changes supplement as well as all pertinent Service Notes.

#### 1-7. SPECIFICATIONS

1-8. Instrument specifications are listed in Table 1-1. These specifications are the performance standards, or limits against which the instrument may be tested.

#### 1-9. SAFETY CONSIDERATIONS

1-10. This product is a Safety Class I instrument (provided with a protective earth terminal). The instrument and manual should be reviewed for safety markings and instructions before operation.

1-11. The Synthesizer and all related documentation must be reviewed for familiarization with safety markings and instructions before operation. Refer to the Safety Considerations page found at

the beginning of this manual for a summary of the safety information.

1-12. Safety information pertinent to the task at hand (installation, operation, performance testing, adjustments, or service) is found throughout this manual.

#### 1-13. INSTRUMENTS COVERED BY MANUAL

1-14. Options. Electrical options 001, 002, 003, 004, 005 and various mechanical options are documented in this manual. The differences are noted under the appropriate paragraph such as Options in Section I, the Replaceable Parts List and the schematic diagrams.

1-15. Serial Numbers. Attached to this instrument is a serial number plate. The serial number is in the form 1234A00123. The first four digits and the letter comprise the serial prefix. The last five digits form the sequential suffix that is unique to each instrument. The contents of this manual apply directly to instruments having the same serial number prefix(es) as listed under SERIAL NUMBERS on the title page.

1-16. For information concerning a serial number prefix not listed on the title page or in the Manual Changes supplement, contact your nearest Hewlett-Packard office.

#### 1-17. MANUAL CHANGE SUPPLEMENTS

1-18. An instrument manufactured after the printing of this manual may have a serial prefix that is not listed on the title page. This unlisted serial prefix indicates that the instrument is different from those documented in this manual. The manual for this instrument is supplied with a yellow Manual Change supplement that contains "change information" that documents the differences.

1-19. In addition to change information, the supplement may contain information for correcting errors in the manual. To keep this manual as current and accurate as possible, Hewlett-Packard recommends that you periodically request the latest Manual Changes supplement. The supplement for this manual is keyed to this manual's print date and part number, both of which appear on the title page. Complimentary copies of the supplement are available from Hewlett-Packard.

1980

Table 1-1. Specifications (1 of 4)

**SPECIFICATIONS**

**FREQUENCY CHARACTERISTICS**

**Range:** 2.0 to 18.0 GHz (overrange to 18.599 997 GHz)

**Resolution:** 1 kHz, 2.0–6.199 999 GHz  
 2 kHz, 6.2–12.399 998 GHz  
 3 kHz, 12.400 002–18.0 GHz

**Time Base:**

**Internal:** 10 MHz; Aging Rate is  $< 5 \times 10^{-10}$  /day after 30 day warmup<sup>1,2</sup>.

**External:** 5 or 10 MHz; 0.1 to 1 Vrms nominal into 50 ohms<sup>3</sup>.

**Reference Outputs:** 10 MHz and 100 MHz, 0.2 Vrms nominal into 50 ohms.

**Frequency Accuracy:** same as time base<sup>2</sup>.

**Switching Time (CW and AM modes):**  $< 15$  ms to be within 1 kHz for frequencies from 2–6.2 GHz, within 2 kHz from 6.2 to 12.4 GHz, and within 3 kHz from 12.4–18 GHz;  $< 15$  ms to be within 3 dB of final amplitude level for any frequency change on the same band.

**SPECTRAL PURITY CHARACTERISTICS**

**Harmonics (up to 18 GHz):**  $< -25$  dBc.

**Sub-harmonics and Multiplies (up to 18 GHz):**  $< -25$  dBc.

**Spurious (CW and AM modes<sup>4</sup>):**

**Non-harmonically related:**  $< -70$  dBc, 2.0–6.2 GHz  
 $< -64$  dBc, 6.2–12.4 GHz  
 $< -60$  dBc, 12.4–18.0 GHz

**Power Line Related and Spurious:** (Due to fan rotation within 5 Hz below line frequency and multiples):

**Power Line Related and Spurious:** (Due to fan rotation; within 5 Hz below line frequency and multiples):

**Option 003 only (400 Hz operation)**

Carrier (F <sub>c</sub> ) Frequency Range (GHz)	Power Line Related and Spurious Levels at Frequency Offset (f <sub>o</sub> ) from Carrier (F <sub>c</sub> )		
	f <sub>o</sub> < 2 kHz	2kHz ≤ f <sub>o</sub> ≤ 8kHz	f <sub>o</sub> > 8 kHz
2.0–6.2	-40 dBc	-50 dBc	-65 dBc
6.2–12.4	-34 dBc	-44 dBc	-59 dBc
12.4–18	-30 dBc	-40 dBc	-55 dBc

**Except Option 003 Instruments (400 Hz operation)**

Carrier(F <sub>c</sub> ) Frequency Range (GHz)	Power Line Related and Spurious Levels At Frequency Offset (f <sub>o</sub> ) From Carrier (F <sub>c</sub> )		
	f <sub>o</sub> < 300 Hz	300Hz ≤ f <sub>o</sub> ≤ 1 kHz	f <sub>o</sub> > 1 kHz
2.0–6.2	-50 dBc	-60 dBc	-65 dBc
6.2–12.4	-44 dBc	-54 dBc	-59 dBc
12.4–18.0	-40 dBc	-50 dBc	-55 dBc

**Single-Sideband Phase Noise (1 Hz BW, CW mode):**

Frequency Range (GHz)	SSB Phase Noise Ratio (in 1 Hz BW, CW mode) at Specified Offset Frequency*				
	10 Hz	100 Hz	1 kHz	10kHz	100 kHz
2.0–6.2	-58dB	-70dB	-78dB	-86dB	-110dB
6.2–12.4	-52dB	-64dB	-72dB	-80dB	-104dB
12.4–18.0	-48dB	-60dB	-68dB	-76dB	-100dB

\*dB referenced to carrier (dBc)

<sup>1</sup> Reference is kept at operating temperature in STAND-BY mode with the instrument connected to Mains power. For instruments disconnected from Mains power less than 24 hours, the aging rate is  $< 5 \times 10^{-10}$  /day after a 24 hour warmup.

<sup>2</sup> Overall accuracy of the internal reference oscillator is a function of time base calibration  $\pm$  aging rate  $\pm$  temperature effects  $\pm$  line voltage effects. Typical temperature and line voltage effects are  $< 1 \times 10^{-10}$  /°C and  $< 5 \times 10^{-10}$  /+5% -10% line voltage change.

<sup>3</sup> Stability and spectral purity will be partially determined by characteristics of external reference oscillator.

<sup>4</sup> External FM signals at rates  $< 100$  kHz must be disconnected.

Table 1-1. Specifications (2 of 4)

## RF OUTPUT CHARACTERISTICS

Level: +3 to -120 dBm, +15°C to +35°C<sup>5,6</sup>.

Total Indicated Meter Accuracy (+15°C to +35°C):<sup>7, 8, 9</sup>

Frequency Range (GHz)	Indicated Meter Accuracy at OUTPUT LEVEL RANGE Switch Setting			
	0 dBm (No Attenuation)	-10 dBm	-20 dBm	-30 dBm and Below
2.0-6.2	±1.75 dB	±2.25 dB	±2.45 dB	±1.75 dB ±0.3 dB/10 dB step below 0 dBm range
6.2-12.4	±2.0 dB	±2.5 dB	±2.7 dB	±2.0 dB ±0.3 dB/10 dB step below 0 dBm range
12.4-18.0	±2.25 dB	±2.85 dB	±3.05 dB	±2.25 dB ±0.4 dB/10 dB step below 0 dBm range

Remote Programming Accuracy<sup>7, 8</sup>: 0.75 dB better than meter accuracy indicated above.

Flatness (0 dBm range, +15°C to +35°C)<sup>7,9</sup>: ±0.75 dB, 2.0-6.2 GHz  
 ±1.00 dB, 2.0-12.4 GHz  
 ±1.25 dB, 2.0-18.0 GHz

Output Level Switching Time: < 20 ms<sup>7,10</sup>.

Impedance: 50 ohms

Source SWR:<sup>11</sup> <2.5

<sup>5</sup> Additional power available on +10 dBm range (overrange), but for power settings above +3 dBm spurious oscillations may degrade performance.

<sup>6</sup> For Option 001 instruments, RF output level specification changes to +5 to -10 dBm from +15 to +35°C; for Option 004, +2.0 dBm max.; Option 005, +4 to -10 dBm from +15 to +35°C; for Option 008, +8 dBm to -120 dBm from +15°C to +35°C. The RF output level also changes when options are combined. When Options 001 and 008 are combined, the RF output level specification is +10 to -10 dBm. When Options 004 and 008 are combined, the RF output level specification is +7 dBm to -120 dBm. However, when Options 005 and 008 are combined, the RF output level specification is +9 dBm to -10 dBm.

<sup>7</sup> Applies for internal leveling only.

<sup>8</sup> Specification includes allowances for meter accuracy (typically ±0.50 dB), detector linearity, temperature, flatness, attenuator accuracy and measurement uncertainty. All but the attenuator accuracy and the measurement error can be calibrated out with a power meter at fixed vernier settings.

<sup>9</sup> For Option 004 and 005 instruments, total indicated meter accuracy and flatness are degraded by an additional ±0.25 dB.

<sup>10</sup> Typically < 10 ms for any change on same output level range.

<sup>11</sup> On the 0 dBm and -10 dBm output level range, specification applies only at the RF output frequency.

Table 1-1. Specifications (3 of 4)

**AMPLITUDE MODULATION CHARACTERISTICS**

**Depth (for meter readings 0 dBm and below, +15°C to +35°C):<sup>12</sup>**

- 0–75% from 2.0–6.2 GHz
- 0–60% from 6.2–12.4 GHz
- 0–50% from 12.4–18.0 GHz

**Rates (3 dB bandwidth):**  
10 Hz–100 kHz.

**Frequency Response (100 Hz–10 kHz rates):**  
±0.25 dB.

**Sensitivity (percent AM per Vpk):**  
30%/V and 100%/V ranges. Maximum input 1 Vpk into 600 ohms nominal.<sup>13</sup>

**Distortion (for rates less than 10 kHz and meter readings 0 dB and below, +15°C to +35°C):**

- <3% at 30% depth
- <4% at 50% depth
- <5% at 75% depth

**Indicated Meter Accuracy (100 Hz–10 kHz rates):** ±5% of range.

**Accuracy Relative to EXT AM Input Level (100 Hz–10 kHz rates):** ±10% of range.

**Incidental  $\phi M$  (Rates ≤ 10 kHz, 30% Depth):**  
<0.5 Rad, 2.0–6.2 GHz  
<1.5 Rad, 6.2–12.4 GHz  
<1.0 Rad, 12.4–18.0 GHz

**Incidental FM:**  
Incidental  $\phi M \times f_{mod}$ .

**FREQUENCY MODULATION CHARACTERISTICS**

**Peak Deviation (maximum):** The smaller of 10 MHz or  $f_{mod} \times 5$ , 2.0–6.2GHz; 10 MHz or  $f_{mod} \times 10$ , 6.2–12.4 GHz; 10 MHz or  $f_{mod} \times 15$ , 12.4–18.0 GHz

**Rates (3 dB bandwidth typical):** 30, 100 kHz/V ranges, 50 Hz to 10 MHz; 300 kHz/V and 1, 3, 10 MHz/V ranges, 1 kHz to 10 MHz.

**Frequency Response (relative to 100 kHz rate):**  
±2.0 dB, 100 Hz–3 MHz, 30 and 100 kHz/V ranges.  
±2.0 dB, 3 kHz–3 MHz, 300 kHz/V and 1, 3, 10 MHz/V ranges.

**Sensitivity (peak deviation per Vpk):**  
30, 100, 300 kHz/V and 1, 3, 10 MHz/V ranges, maximum input 1 Vpk into 50 ohms nominal.<sup>14</sup>

**Harmonic and Non-Harmonic Distortion:<sup>15</sup>** <12% for rates < 3 kHz, decreasing linearly with frequency to 5% at 20 kHz rate. < 5% for 20 to 100 kHz rates.

**Residual FM in FM and CW Modes (noise and power line related)<sup>16</sup>:**

Mode/Range	Residual FM in Post Detection Bandwidth	
	20 Hz–1 kHz	20 Hz–3 kHz
CW and 30 kHz/V thru 3 MHz/V ranges	6 Hz–rms	12 Hz–rms
10 MHz/V range	10 Hz–rms	20 Hz–rms

**Indicated Meter Accuracy (at 100 kHz rate):<sup>17</sup>**  
±10% of full scale at +15°C to +35°C.  
±15% of full scale at 0 to +55°C.

**Accuracy Relative to External Input Level (at 100 kHz rate):<sup>17</sup>** ±7% of range at +15°C to +35°C  
±10% of range at 0 to +55°C.

**Incidental AM (rates ≤100 kHz, peak deviation ≤1 MHz):**  
< 10%.

<sup>12</sup> The meter reading of output power level when using AM is carrier level only (i.e., does NOT include power in AM sidebands).

<sup>13</sup> 1.0V peak gives maximum depth on each range. AM depth is linearly controlled by varying input level between 0 and 1 Vpk.

<sup>14</sup> 1 Vpk gives maximum deviation on each range. Peak deviation is linearly controlled by varying input level between 0 and 1 Vpk.

<sup>15</sup> For certain FM modulating frequencies, spurious FM signals (non-harmonic distortion) may occur. After demodulation in an external FM discriminator, the contribution to distortion of these spurious FM signals is typically less than 0.6%.

<sup>16</sup> Residual FM doubles in 6.2–12.4 GHz range; triples in 12.4–18.0 GHz range.

<sup>17</sup> For FM rates other than 100 kHz, add FM frequency response specification.

Table 1-1. Specifications (4 of 4)

<b>REMOTE PROGRAMMING CHARACTERISTICS</b>	
<p><b>Frequency:</b> Programmable over full range (up to 18.599 997 GHz) with same resolution as in manual mode.</p> <p><b>Output Level:</b> Programmable in 1 dB steps, +3 to -120 dBm, plus the 10 dB of overrange.</p>	<p><b>AM Modulation:</b> OFF, 30%/Vpk, and 100%/Vpk ranges.</p> <p><b>FM Modulation:</b> OFF; 30, 100, 300 kHz/Vpk; 1, 3, 10 MHz/Vpk ranges.</p> <p><b>Other:</b> RF ON, RF OFF, ALC INT, ALC EXT XTAL, ALC EXT, PWR MTR.</p> <p><b>Programming Format:</b> HP-IB (Hewlett-Packard Interface Bus).</p>
<b>GENERAL CHARACTERISTICS</b>	
<p><b>Operating Temperature Range:</b> 0° to 55°C.</p> <p><b>Leakage:</b> Meets radiated and conducted limits of MIL-I-6181D.</p>	<p><b>Power:</b> 100, 120, 220, or 240V, +5%, -10% 48-66 Hz 300 VA maximum.</p> <p><b>Net Weight:</b> 27.2 kg (60 lb).</p> <p><b>Dimensions:</b> 600 mmD x 425 mmW x 133 mmH (23-5/8" x 16-3/4" x 5-1/4").</p>

## 1-20. DESCRIPTION

1-21. The HP Model 8672A Synthesized Signal Generator has a frequency range of 2000 to 18 000 MHz. The output is leveled and calibrated from +3 to -120 dBm. AM and/or FM modulation modes can be selected. The frequency, output level, modulation modes, and most other modes or functions can be remotely controlled using the HP-IB programming format.

### 1-22. Frequency

1-23. Frequencies from 2000 to 18 000 MHz (overrange to 18 599.997 MHz) can be tuned from the front panel. Minimum resolution is 1 kHz from 2000 to 6199.999 MHz, 2 kHz from 6200 to 12 399.998 MHz and 3 kHz from 12 400.002 to 18 000 MHz. Tuning resolutions of 100 MHz, 1 MHz, 10 kHz, or 1 kHz minimum are selected by front panel pushbuttons.

1-24. Frequency stability is dependent on the time base, either an internal or external oscillator. The internal crystal oscillator operates at 10 MHz while an external oscillator must operate at 5 or 10 MHz. The heart of the Synthesizer, a YIG tuned oscillator (YTO), is phase-locked to the time base oscillator.

### 1-25. Output Level

1-26. The output of the Synthesizer is exceptionally flat due to the action of the internal auto-

matic leveling control (ALC) loop. The accuracy of the total indicated output level (the sum of the front panel meter reading and the attenuator range) is increased.

1-27. The OUTPUT LEVEL VERNIER controls the output level as indicated by the front panel meter (+3 to -10 dB). The OUTPUT LEVEL RANGE switch sets the attenuation of the output level in twelve 10 dB steps (0 to -110 dBm). The +10 dBm range (overrange) is also controlled by the OUTPUT LEVEL RANGE switch.

### 1-28. Modulation Modes

1-29. Both amplitude and frequency modulation capabilities are available in the instrument using either front panel switches or remote programming. External drive signals are used for both AM and FM operation. AM depth and FM deviation are linear with the applied external voltage. Full scale modulation is attained with 1.0 V-peak.

1-30. Two ranges of AM depth are selectable either from the front panel or via remote programming. The front panel meter can be used to set the AM depths of up to 75% between 2000 MHz and 6200 MHz, up to 60% between 6200 MHz and 12 400 MHz, and 50% between 12 400 MHz and 18 000 MHz. Amplitude modulation can be performed at any frequency between 10 Hz and 100 kHz.

1-31. FM peak deviation can be set using the front panel meter. At output frequencies below 6200 MHz, peak deviation is limited to 10 MHz or five times the modulation frequency, whichever is lower. From 6200 to 12 400 MHz, peak deviation is limited to the lesser of 10 MHz or ten times the modulation frequency; from 12 400 to 18 000 MHz the lesser of 10 MHz or fifteen times the modulation frequency. Usable modulation rates fall between 50 Hz and 10 MHz. Six ranges of deviation sensitivity are selectable either by the front panel switches or via remote programming.

### 1-32. Miscellaneous Outputs and Indicators

1-33. The front panel meter indicates output level, AM depth, or FM peak deviation. The meter mode is selected by a front panel switch.

1-34. External leveling is selected by a front panel switch. A power meter or crystal detector may be used as the leveling loop detector.

1-35. Phase-locked reference outputs of 10 and 100 MHz are available on the rear panel.

1-36. Six front panel status indicators make the Synthesizer operation easier and aids in reducing possible operator error.

### 1-37. Remote Operation

1-38. The Synthesizer is fully programmable via the Hewlett-Packard Interface Bus. In the remote mode all front panel controls are disabled except the LINE and METER MODE switches.

1-39. The output level is selected in 1 dB steps. The programmed output level is more accurate than can be obtained in the local mode. This occurs because the output level is set by programming rather than being set by monitoring the meter reading. The meter reading may be in error due to meter nonlinearity.

## 1-40. OPTIONS

### 1-41. Electrical Options

1-42. Option 001. The RF Output connector is mounted on the front panel but the internal attenuator is omitted. The specified output level is +5 to -10 dBm.

1-43. Option 002. The internal 10 MHz crystal reference is omitted.

1-44. Option 003. A special fan allows operation from 400 Hz power Mains.

1-45. Option 004. The Synthesizer's RF output connector is located on the rear panel. Maximum output power is +2.0 dBm. Total indicated level accuracy and flatness is degraded by  $\pm 0.25$  dB.

1-46. Option 005. The Synthesizer's RF output connector is located on the rear panel and the attenuator is omitted. The specified output power is +4.0 to -10 dBm. Total indicated level accuracy and flatness is degraded by  $\pm 0.25$  dB.

### 1-47. Mechanical Options

1-48. The following options may have been ordered and received with the Synthesizer. If they were not received with the original shipment and are now required, they must be ordered from your nearest Hewlett-Packard office using the part number included in each of the following paragraphs.

1-49. Chassis Slide Mount Kit. This kit is extremely useful when the Synthesizer is rack mounted. Access to internal circuits and components, or the rear panel is possible without removing the Synthesizer from the rack. Order HP part number 1494-0017. When this kit comes with the Synthesizer, it is identified as Option 006. If the instrument rack mounting slides are to be mounted in a standard EIA rack, then an adapter (HP Part No. 1494-0023) is needed. The slides without the adapter can be directly mounted in the HP system enclosures.

1-50. Front Handle Kit. Ease of handling is increased with the front panel handles. Order HP part number 5061-0089.

1-51. Rack Flange Kit. The Synthesizer can be solidly mounted to the instrument rack using this kit. Order HP part number 5061-0077.

1-52. Rack Flange and Front Handle Combination Kit. This kit is not a front handle kit and rack flange kit packaged together. The combination is made up of a unique part which includes both functions. Order HP part number 5061-0083.

### 1-53. COMPATIBILITY

1-54. The Synthesizer is compatible with HP-IB as indicated by the following code: AH1, C0, DC1, DT0, L4, LE0, PP2, RL2, SH1, SR1, T6 and TE0. An explanation of the compatibility code may be



found in the IEEE Standard 488-1975, "IEEE Standard Digital Interface for Programmable Instrumentation."

1-55. For more detailed information relating to programmable control of the Synthesizer, refer to Section III in this manual.

#### 1-56. SELECTING THE HP-IB ADDRESS

1-57. The HP-IB address switches are located within the Synthesizer. The switches represent a two-digit octal number. This number corresponds to talk and listen address characters which an HP-IB controller is capable of generating. A table in Section II shows all HP-IB talk and listen addresses. Refer to the paragraph entitled HP-IB Address and Parallel Poll Response Selection in Section II.

#### 1-58. ACCESSORIES SUPPLIED

1-59. The accessories supplied with the Synthesizer are shown in Figure 1-1.

a. The line power cable may be supplied in several combinations of plugs. Refer to Power Cables in Section II.

b. Fuses with a 3.0A rating for 100/120 Vac (HP 2110-0003) and a 1.5A rating for 220/240 Vac (HP 2110-0043) are supplied. One fuse is factory installed according to the voltage available in the country of destination. Refer to Line Voltage Selection in Section II.

c. There are four extender boards supplied which aid in performance testing, adjusting, and troubleshooting the instrument.

1. One 30-pin (15 x 2) extender board, HP part number 08672-60117.
2. Two 36-pin (18 x 2) extender boards, HP part number 08672-60020.
3. One 3-section, 30-pins (15 x 2) per section, extender board, HP part number 08672-60016 (for use in the A2 Assembly).

#### 1-60. EQUIPMENT REQUIRED BUT NOT SUPPLIED

1-61. For Option 002 instruments which lack an internal frequency standard, an external reference must be used. The performance of the external reference should at least match the specifications

and, in particular, the frequency accuracy<sup>1</sup> and spectral purity of the HP Model 10544C Crystal Oscillator. When using an external oscillator, microphonics or line related spurious signals may increase.

1-62. An external signal source is required if amplitude or frequency modulation is desired. For AM, the source should have a variable output of 0 to 1 Vpk into 600 ohms, modulation rates up to 100 kHz, and distortion of <1%. For FM, the source should have a variable output of 0 to 1 Vpk into 50 ohms, modulation rates up to 10 MHz, and distortion of <1%. The HP 651B and 654A test oscillators are adequate for modulating the Synthesizer and meet the stated requirements.

1-63. A remotely programmable audio source would be convenient for full remote control of modulation levels and rates.

#### 1-64. EQUIPMENT AVAILABLE

1-65. The Synthesizer has an HP-IB interface and can be used with any HP-IB compatible computing controller or computer for automatic systems applications.

1-66. The 11712A Support Kit is available to aid the user in maintaining and servicing the Synthesizer. It consists of cables, adaptors, terminations, prerecorded programs, extender boards and a test extender board.

1-67. The prerecorded programs are on tape cassettes and are for use with the HP 9830A and HP 9825A Computing Controllers. The Output Register Test Board is intended to aid in troubleshooting the frequency control circuits.

1-68. Refer to the 11712A Support Kit operating manual for additional information. It may be ordered through your nearest Hewlett-Packard office.

#### 1-69. RECOMMENDED TEST EQUIPMENT

1-70. Table 1-2 lists the test equipment and accessories recommended for use in testing, adjusting, and servicing the Synthesizer. If any of the recommended equipment is unavailable, instruments with equivalent minimum specifications may be used.

<sup>1</sup> Frequency Accuracy: needed 1 ppm; minimum requirement 10 ppm.



## SECTION II INSTALLATION

### 2-1. INTRODUCTION

2-2: This section provides the information needed to install the Synthesizer. Included is information pertinent to initial inspection, power requirements, line voltage selection, power cables, interconnection, environment, instrument mounting, storage and shipment.

### 2-3. INITIAL INSPECTION

#### WARNING

*To avoid hazardous electrical shock, do not perform electrical tests when there are signs of shipping damage to any portion of the outer enclosure (covers, panels, meters).*

2-4. Inspect the shipping container for damage. If the shipping container or cushioning material is damaged, it should be kept until the contents of the shipment have been checked for completeness and the instrument has been checked mechanically and electrically. The contents of the shipment should be as shown in Figure 1-1. Procedures for checking electrical performance are given in Section IV. If the contents are incomplete, if there is mechanical damage or defect, or if the instrument does not pass the electrical performance test, notify the nearest Hewlett-Packard office. If the shipping container is damaged, or the cushioning material shows signs of stress, notify the carrier as well as the Hewlett-Packard office. Keep the shipping materials for the carrier's inspection.

### 2-5. PREPARATION FOR USE

#### 2-6. Power Requirements

2-7. The Synthesizer requires a power source of 100, 120, 220, or 240 Vac, +5% to -10%, 48 to 60 Hz single phase (for Option 003 instruments, 400 Hz single phase and 120 Vac, +5%, -10% only). Power consumption is approximately 300 volt-amperes.

#### WARNINGS

*This is a Safety Class I product (provided with a protective earthing terminal). An uninterruptible safety earth*

*ground must be provided from the main power source to the product input wiring terminals, power cord, or supplied power cord set. Whenever it is likely that the protection has been impaired, the product must be made inoperative and be secured against any unintended operation.*

*If this instrument is to be energized via an autotransformer for voltage reduction, make sure the common terminal is connected to the earthed pole of the power source.*

### 2-8. Line Voltage and Fuse Selection

#### CAUTION

*BEFORE PLUGGING THIS INSTRUMENT into the Mains (line) voltage, be sure the correct voltage and fuse have been selected.*

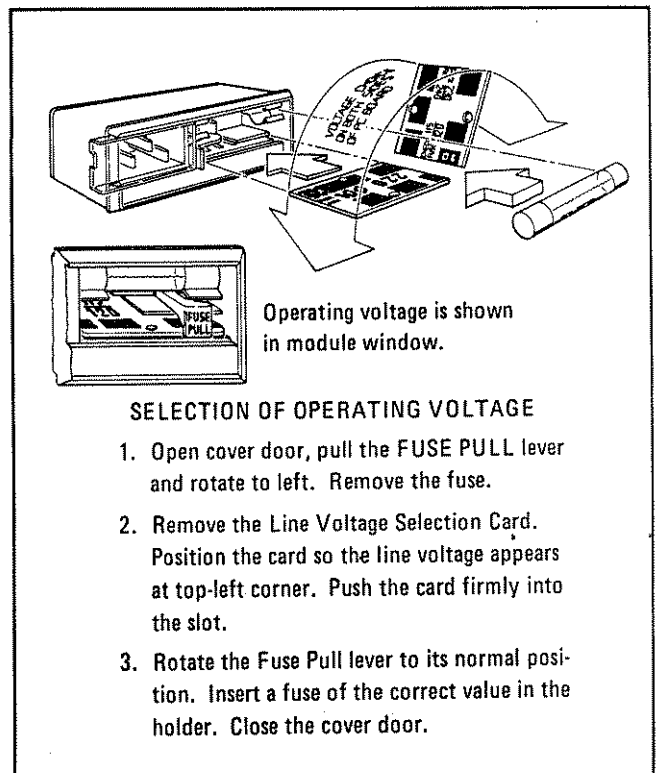

Figure 2-1. Line Voltage and Fuse Selection

2-9. Verify that the line voltage selection card and the fuse are matched to the power source. Refer to Figure 2-1, Line Voltage and Fuse Selection.

2-10. Power Cable

**WARNING**

*BEFORE CONNECTING THIS INSTRUMENT, the protective earth terminals of this instrument must be connected to the protective conductor of the (Mains) power cord. The Mains plug shall only be inserted in a socket outlet provided with a protective earth contact. The protective action must not be negated by the use of an extension cord (power cable) without a protective conductor (grounding).*

2-11. This instrument is equipped with a three-wire power cable. When connected to an appropriate ac power receptacle, this cable grounds the instrument cabinet. The type of power cable plug shipped with each instrument depends on the country of destination. Refer to Figure 2-2 for the part numbers of the power cable available.

2-12. HP-IB Address and Parallel Poll Response Selection

2-13. In the Synthesizer, the HP-IB talk and listen addresses and the parallel poll sense and response line are switch selectable. The following procedure explains how the switches are to be set. Refer to Table 2-1 for a listing of the talk and listen address.

2-14. To change the HP-IB address or to select a different parallel poll response, the top cover of the Synthesizer and the internal A2 Assembly's cover must be removed.

- a. Disconnect the line (Mains) power cable.
- b. Remove any HP-IB cables or connectors from the HP-IB connector.
- c. Remove the Synthesizer's top cover and the A2 Assembly's protective cover. Refer to the Disassembly and Reassembly Procedures in Section VIII.
- d. If the parallel poll sense or response switches are to be changed, remove the A2A9 Board Assembly.
- e. Select the new address as shown in Table 2-1. The location of the switches are shown on

<p>220/240V OPERATION</p>  <p>PLUG*: SEV 1011.1959-24507 TYPE 12 CABLE*: HP 8120-2104</p>	<p>220/240V OPERATION</p>  <p>PLUG*: NZSS 198/AS C112 CABLE*: HP 8120-1369</p>	<p>100/120V OPERATION</p>  <p>PLUG*: NEMA 5-15P CABLE*: 8120-1378</p>	<p>220/240V OPERATION</p>  <p>PLUG*: NEMA 6-15P CABLE*: HP 8120-0698</p>
<p>220/240V OPERATION</p>  <p>PLUG*: CEE7-VII CABLE*: HP 8120-1689</p>	<p>220/240V OPERATION</p>  <p>PLUG*: CEE22-V1 CABLE*: HP 8120-1860</p>	<p>220/240V OPERATION</p>  <p>PLUG*: BS 1363A CABLE: HP 8120-1351</p>	
<p>*The number shown for the plug is the industry identifier for the plug only. The number shown for the cable is an HP part number for a complete cable including the plug.</p>			

Figure 2-2. Power Cable and Mains Plug Part Numbers

**HP-IB Address and Parallel Poll Response Selection (cont'd)**

Figure 2-3. The HP-IB ADDRESS SELECT switch settings (for S2 and S3) are in the octal code. For example, the factory selected addresses are set to 23 (binary 10 011; equivalent to bits b5 through b1 on the table). Therefore, the listen address is '3' and the talk address is 'S'.

f. The PARALLEL POLL SENSE switch (S4) is set to either the OFF, 0 (zero) or 1 (one) position. In the zero position, the less positive level indicates an affirmative response to the poll.

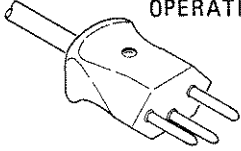
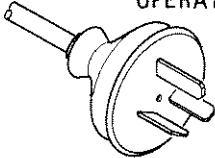
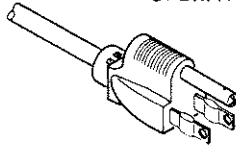
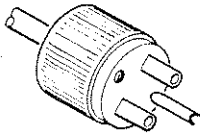
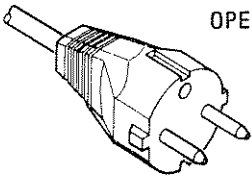
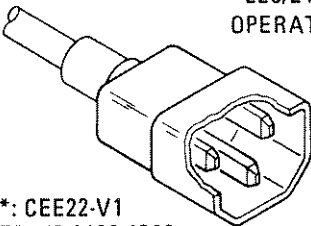
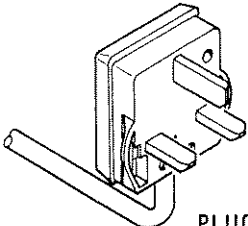
g. The PPR (Parallel Poll Response) switch (S1) is set to select one-of-eight lines (one of 1 through 8). The selected line passes the Synthesizer's response to the parallel poll to the HP-IB controller.

h. Re-install the A2A9 Assembly.

i. Replace the A2 Assembly's internal cover and the Synthesizer's top cover.

j. Connect the line (Mains) power cable to the Line Power Module; connect the HP-IB cable to the HP-IB connector.

**2-15. Interconnections**

2-16. Interconnection data for the Hewlett-Packard Interface Bus is provided in Figure 2-4.

**2-17. Mating Connectors**

2-18. **Interface Connector.** The HP-IB mating connector is shown in Figure 2-4.

2-19. **Coaxial Connectors.** Coaxial mating connectors used with the Synthesizer should be 50-ohm Type-N male connectors that are compatible with those specified in US MIL-C-39012.

**2-20. Operating Environment**

2-21. The operating environment should be within the following limitations:

Temperature .....	0°C to +55°C
Humidity .....	< 95% relative
Altitude .....	< 4570 metres (15 000 feet)

**NOTE**

*RF Output accuracy, flatness and maximum power will meet specifications only between 15 and 35°C.*

**2-22. Bench Operation**

2-23. The instrument cabinet has plastic feet and fold-away tilt stands for convenience in bench operation. (The plastic feet are shaped to ensure self-aligning of the instruments when stacked.) The tilt stands raise the front of the instrument for easier viewing of the control panel.

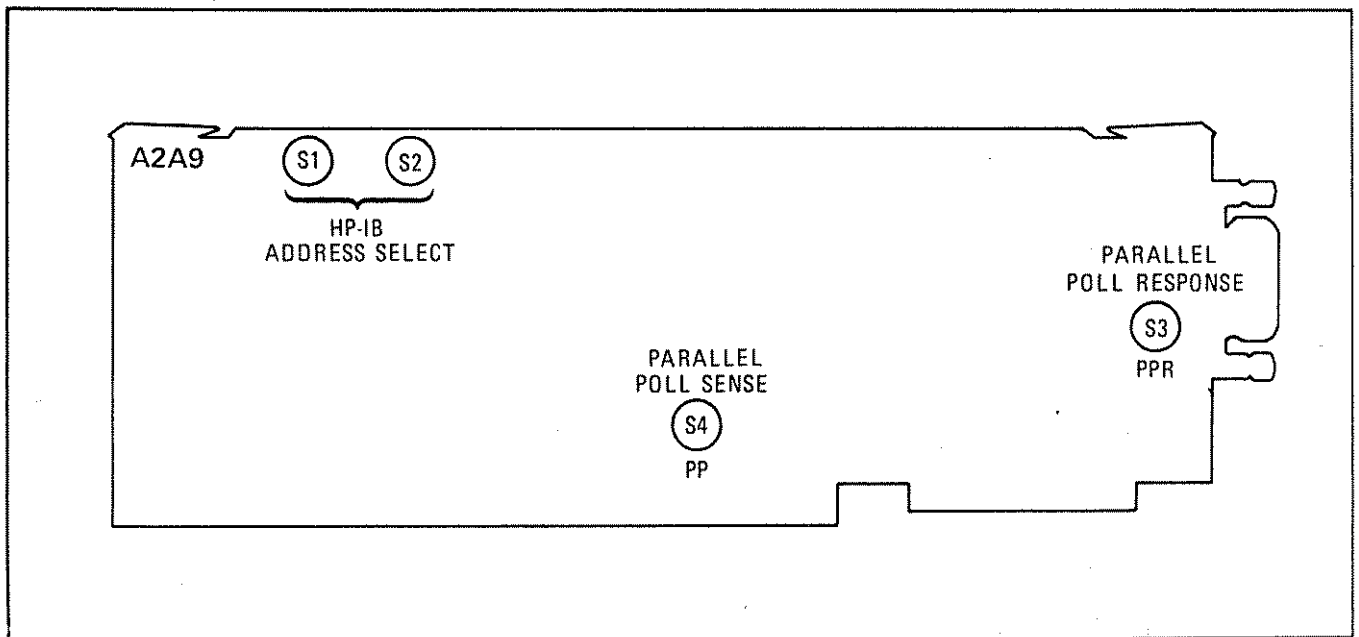

**Figure 2-3. Location of HP-IB Address and Parallel Poll Switches**

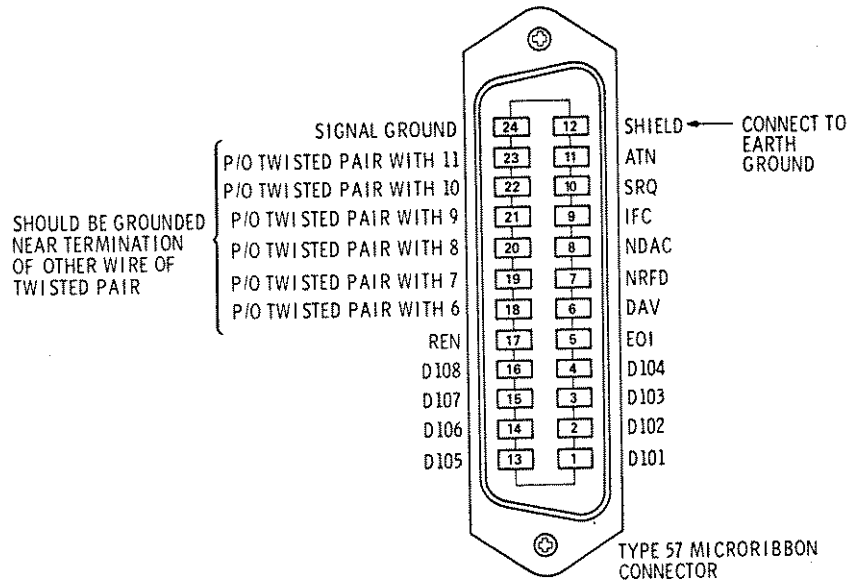

**Logic Levels**

The Hewlett-Packard Interface Bus logic levels are TTL compatible, i.e., the true (1) state is 0.0 Vdc to +0.4 Vdc and the false (0) state is +2.5 Vdc to +5.0 Vdc.

**Programming and Output Data Format**  
Refer to Section III, Operation.

**Mating Connector**  
HP 1251-0293; Amphenol 57-30240.

**Mating Cables Available**  
HP 10631A, 0.9 metres (3 ft.), HP 10631B, 1.8 metres (6 ft.)  
HP 10631C, 3.7 metres (12 ft.)

**Cablings Restrictions**

1. A Hewlett-Packard Interface Bus System may contain no more than 1.8 metres (6 ft.) of connecting cable per instrument.
2. The maximum accumulative length of connecting cable for any Hewlett-Packard Interface Bus System is 20.0 metres (65.6 ft.)

Figure 2-4. Hewlett-Packard Interface Bus Connection

Table 2-1. USA Standard Code for Information Interchange (ASCII)

b7 b6 b5 BITS									0 <sub>00</sub>	0 <sub>01</sub>	0 <sub>10</sub>	0 <sub>11</sub>	1 <sub>00</sub>	1 <sub>01</sub>	1 <sub>10</sub>	1 <sub>11</sub>	} NOTE 3
					b <sub>4</sub>	b <sub>3</sub>	b <sub>2</sub>	b <sub>1</sub>	Column→	0	1	2	3	4	5	6	
					Row↓	0	1	2	3	4	5	6	7				
0	0	0	0	0	0	NUL	DLE	SP	0	@	P	`	p				
0	0	0	1	1	1	SOH	DC1	!	1	A	Q	a	q				
0	0	1	0	0	2	STX	DC2	"	2	B	R	b	r				
0	0	1	1	1	3	ETX	DC3	#	3	C	S	c	s				
0	1	0	0	0	4	EOT	DC4	\$	4	D	T	d	t				
0	1	0	1	1	5	ENQ	NAK	%	5	E	U	e	u				
0	1	1	0	0	6	ACK	SYN	&	6	F	V	f	v				
0	1	1	1	1	7	BEL	ETB	'	7	G	W	g	w				
1	0	0	0	0	8	BS	CAN	(	8	H	X	h	x				
1	0	0	1	1	9	HT	EM	)	9	I	Y	i	y				
1	0	1	0	0	10	LF	SUB	*	:	J	Z	j	z				
1	0	1	1	1	11	VT	ESC	+	;	K	[	k	{				
1	1	0	0	0	12	FF	FS	,	<	L	\	l					
1	1	0	1	1	13	CR	GS	-	=	M	]	m	}				
1	1	1	0	0	14	SO	RS	.	>	N	^	n	~				
1	1	1	1	1	15	SI	US	/	?	O	_	o	DEL				

NOTE 3

NOTE 1

NOTE 2

- NOTE 1: HP-IB valid LISTEN addresses
- NOTE 2: HP-IB valid TALK addresses
- NOTE 3: Logic 1 = 0V

2-24. Rack Mounting

**WARNING**

*The Synthesizer is heavy for its size (27.2 kg, 60 lb). Care must be exercised when lifting to avoid personal injury. Use equipment slides when rack mounting.*

2-25. Rack Mounting information is provided with the rack mounting kits. If the kits were not ordered with the instrument as options, they may be ordered through the nearest Hewlett-Packard

office. Refer to the paragraph entitled Options in Section I.

2-26. STORAGE AND SHIPMENT

2-27. Environment

2-28. The instrument should be stored in a clean dry environment. The following environmental limitations apply to both storage and shipment:  
 Temperature ..... -55°C to +75°C  
 Humidity..... < 95% relative  
 Altitude..... < 15 300 metres (50 000 feet)

**2-29. Packaging**

**2-30. Original Packaging.** Containers and materials identical to those used in factory packaging are available through Hewlett-Packard offices. If the instrument is being returned to Hewlett-Packard for servicing, attach a tag indicating the type of service required, return address, model number, and full serial number. Also mark the container FRAGILE to assure careful handling. In any correspondence refer to the instrument by model number and full serial number.

**2-31. Other Packaging.** The following general instructions should be used for re-packaging with commercially available materials:

a. Wrap the instrument in heavy paper or plastic. (If shipping to a Hewlett-Packard office or

service center, attach a tag indicating the service required, return address, model number, and full serial number.)

b. Use a strong shipping container. A double-wall carton made of 2.4 MPa (350 psi) test material is adequate.

c. Use enough shock-absorbing material (75 to 100 mm layer; 3 to 4 inches) around all sides of instrument to provide firm cushion and prevent movement in the container. Protect the control panel with cardboard.

d. Seal the shipping container securely.

e. Mark the shipping container FRAGILE to assure careful handling.



## SECTION III OPERATION

### 3-1. INTRODUCTION

3-2. This section explains how to operate the Synthesizer. Included in this section are descriptions of all front and rear panel controls, connectors and indicators, operator's checks, operating instructions, and operator's maintenance.

3-3. Local operating instructions begin with paragraph 3-10. Remote operation with the Hewlett-Packard Interface Bus (HP-IB) is explained beginning with paragraph 3-16.

### 3-4. PANEL FEATURES

3-5. The front and rear panel features of the Synthesizer are shown in Figures 3-1 and 3-2, and are described in Tables 3-1 and 3-2. The tables contain detailed descriptions of the controls, connectors, and indicators.

### 3-6. OPERATOR'S MAINTENANCE

3-7. The only maintenance the operator should normally perform is the replacement of the primary power fuse (F1) located in the Line Power Module Assembly ⑨ (A3A11) shown in Figure 3-2 and the mechanical zero adjustment ⑫ of the meter shown in Figure 3-1. For instructions on how to change the fuse, refer to Section II, Line Voltage Selection.

### 3-8. Mechanical Meter Zeroing

3-9. To mechanically zero the front panel meter ② (see Figure 3-1), set the LINE switch ⑫ to the STANDBY position and place the Synthesizer in its normal operating position. Turn the mechanical zeroing adjustment clockwise to move the needle up scale or counter-clockwise to move the needle down scale. The zero point is located at the left end of the 0-1 or the 0-3 scales. DO NOT zero on the left end of the top dB scale at -10 as this is not the proper zeroing point.

### 3-10. LOCAL OPERATION

#### WARNINGS

*Before the instrument is switched on, all protective earth terminals, extension*

*cords, auto-transformers and devices connected to it should be connected to a protective earth grounded socket. Any interruption of the protective earth grounding will cause a potential shock hazard that could result in personal injury.*

*Only fuses with the required rated current and specified type should be used. Do not use repaired fuses or short circuited fuseholders. To do so could cause a shock or fire hazard.*

#### CAUTION

*Before the instrument is switched on, it must be set to the voltage of the power source, or damage to the instrument may result.*

3-11. A procedure for verifying the major functions of the Synthesizer is provided in Tables 3-3 and 3-4. The procedure is divided into two parts: Local Operator's Checks and Local Operating Instructions. The Local Operator's Checks should be performed first to verify proper operation of the Synthesizer. The Local Operating Instructions explain how to set and use the Synthesizer's controls.

### 3-12. LOCAL OPERATOR'S CHECK

3-13. Table 3-3 provides general instructions for checking the operation of the Synthesizer via the front and rear panel controls.

### 3-14. LOCAL OPERATING INSTRUCTIONS

3-15. Table 3-4 provides general instructions for operating the Synthesizer via the front and rear panel controls.

#### WARNING

*Any interruption of the protective (grounding) conductor (inside or outside the instrument) or disconnecting the protective earth terminal is likely to make this instrument dangerous. Intentional interruption is prohibited.*

Table 3-1. Front Panel Features (1 of 2)

## FRONT PANEL FEATURES

- 1 RANGE dBm:** LED display indicates the sign and selected range of the RF output in 10 dB steps from -110 to +10 dBm. RANGE is determined by the setting of the OUTPUT LEVEL RANGE selector **24** or remotely programmed.
- 2 Meter:** automatically ranges to one of three scales, read according to position of METER MODE selector **28**.
- LEVEL:** -10 to +3 dB scale indication. LEVEL is determined by the setting of the OUTPUT LEVEL VERNIER control **20** or remotely programmed and read relative to the RANGE dBm **1** level displayed.
- AM:** 0 to 3 scale is read 0 to 30% and the 0 to 1 scale is read 0 to 100% depending on the setting of the AM selector **15** and displayed by the AM annunciator **5**.
- FM:** 0 to 3 scale is read 0 to 0.03 MHz, 0 to 0.3 MHz, and 0 to 3 MHz; and the 0 to 1 scale read 0 to 0.1 MHz, 0 to 1.0 MHz, and 0 to 10 MHz. Depends on the position of the FM DEVIATION MHz selector **18** and is displayed by the FM annunciator **6**.
- 3 RF annunciator:** ON-OFF indicates when the RF OUTPUT **26** is enabled or disabled, controlled by the RF switch **27** or remotely programmed.
- OVER RANGE:** indicates when the +10 dBm range is selected or remotely programmed.
- 4 ALC annunciator:** indicates whether the ALC (Automatic Level Control) is INT (internal), external XTAL (crystal), or external MTR (Power Meter) as determined by the position of the ALC selector **17**. LEV UNCAL indicates an unlevelled output or an illegal range was programmed remotely (<-110 dBm).
- 5 AM annunciator:** indicates OFF, 30%, or 100% modulation range as determined by the AM selector **15** or as remotely programmed.
- 6 FM annunciator:** indicates OFF, 0.03, 0.1, 0.3, 1, 3, and 10 MHz deviation range for 1 Vpk. Deviation range is determined by the position of the FM DEVIATION MHz selector **18** or remotely programmed. OVER MOD indicates an input signal greater than 1 Vpk at the FM INPUT connector **16** or that the modulation index is greater than 5, 10, or 15 depending on the band.
- 7 FREQUENCY MHz:** LED display indicates the selected frequency.
- 8 Frequency Resolution Light Bars:** indicate the frequency tuning resolution selected by the FREQUENCY RESOLUTION keys **13**. The first light bar indicates 100 MHz resolution, the second indicates 1 MHz, the third indicates 10 kHz, and the fourth indicates 1 kHz resolution. The light bars to the left of the one selected will also light.
- 9 STATUS Block:** annunciators display the internal conditions of the Synthesizer.
- OVEN:** when lit, indicates that the crystal oven is not up to operating temperature.
- OUT OF RANGE:** when lit, indicates an out of range (illegal) frequency has been remotely programmed.
- REMOTE:** when lit, indicates the Synthesizer is set to remote operation by an HP-IB controller.
- STANDBY:** when lit, indicates that power is applied but the LINE switch **12** is in the STANDBY position.
- NOT PHASE LOCKED:** indicates that one or more of the phase lock loops are unlocked or the RF switch **27** is in the OFF position.
- INTERNAL REF OFF:** when lit, indicates when the rear panel INT-EXT switch **27** (see Figure 3-2) is in the EXT position.
- 10 HOLD key:** disables the TUNING control **14** on the front panel and extinguishes the Frequency Resolution Light Bars **8**.
- 11 PRESET key (3 GHz):** sets frequency to 3 GHz and extinguishes the Frequency Resolution Light Bars **8**.

Table 3-1. Front Panel Features (2 of 2)

- 12 LINE switch:** applies power to the Synthesizer when set to the ON position; power is supplied to the crystal oven and the battery charger circuit in the STANDBY position.
- 13 FREQUENCY RESOLUTION pushbuttons:** selects tuning resolution in 100 MHz, 1 MHz, 10 kHz, or 1, 2, or 3 kHz steps (depending on the frequency selected). The HOLD switch **10** clears any frequency resolution selected.
- 14 TUNING control:** changes the Synthesizer's output frequency by the increments selected by the FREQUENCY RESOLUTION selectors **13**.
- 15 AM function switch:** selects OFF, 30%/V, or 100%/V modulation by a signal applied to the AM INPUT connector **19**. The selected range is displayed on the AM annunciator **5**. Modulation percentage is read on the Meter **2** when the METER MODE selector **28** is set to AM. AM may be remotely programmed.
- 16 FM INPUT connector:** accepts a maximum 1 Vpk external modulation signal (50Ω source impedance). Deviation varies linearly with the input signal. Deviation ranges are controlled by the FM DEVIATION switch **18** or remotely programmed.
- 17 ALC switch:** selects either internal (INT) leveling, external crystal (XTAL), or external power meter (PWR MTR) leveling. The external leveling device (crystal or power meter) may have either a positive or negative output. The ALC selector can be remotely programmed.
- 18 FM DEVIATION MHz switch:** selects the meter scale and peak deviation that is obtained with a signal applied to the FM INPUT connector **16**. The peak deviation range is displayed on the FM annunciator **6** and the actual peak deviation is read from the selected scale on the Meter **2**. The FM DEVIATION MHz selector can be remotely programmed.
- 19 AM INPUT connector:** accepts a maximum 1 Vpk external modulation signal (600 ohm impedance). A 1 Vpk signal develops full scale modulation as selected by the AM selector **15** or as programmed remotely. Percent modulation varies linearly with the input signal.
- 20 OUTPUT LEVEL VERNIER:** adjusts the RF output level over the range of +3 to -10 dB, relative to the Output Level Range as read on the Meter **2**. The Vernier function is programmable in 1 dB steps.
- 21 EXT ALC INPUT connector:** accepts positive or negative leveling signals from either a power meter or crystal detector as selected by the ALC selector **17**.
- 22 Mechanical Meter Zero:** sets meter suspension so the Meter **2** indicates zero when power is removed from the Synthesizer and the Synthesizer is in its normal operating position.
- 23 CAL control:** adjusts the ALC gain to match the external leveling device in use. The CAL control must be returned to the fully clockwise position when the Synthesizer is returned to internal leveling.
- 24 OUTPUT LEVEL RANGE:** selects the RF output level range in 10 dB steps from +10 to -110 dBm. The selected range is displayed by the RANGE dBm LED readout **1**. The range may also be programmed remotely.
- 25 PEAK-NORM control:** generally left in the NORM detented position (fully clockwise). It is used to peak the RF output at a particular frequency in the band at the expense of power at other frequencies.
- 26 RF OUTPUT connector:** 50 ohm type-N female connector supplies the RF output over the entire frequency range of 2 to 18 GHz.
- 27 RF switch:** completely turns off the RF output when in the OFF position. This condition is displayed in the RF annunciator **3** and causes the NOT PHASE LOCKED annunciator in the STATUS Block **9** to illuminate. When the ON position is selected, the Synthesizer returns to normal operation. The functions of the RF switch are programmable.
- 28 METER MODE switch:** selects either LEVEL, AM, or FM to be displayed on the meter **2**.

Table 3-2. Rear Panel Features

- 1 **HP-IB CONNECTOR:** connects the Synthesizer to the Hewlett-Packard Interface Bus for remote operation. When in remote operation, the STATUS Block (see Figure 3-1) 9 REMOTE annunciator illuminates.
- 2 **100 MHz OUT (A3J7):** 0 dBm (nominal) into 50 ohms, can be used as an external timebase and for troubleshooting.
- 3 **RF OUT (A3J6):** only for Options 004 and 005, 50 ohm type N output connector (see Table 1-1 for Option information).
- 4 **10 MHz OUT (A3J8):** 0 dBm (nominal) into 50 ohms, can be used as an external timebase and for troubleshooting.
- 5 **FREQ STANDARD Output (A3J9):** 10.000 MHz into 50 ohms at +7 dBm (nominal) from the internal frequency standard except when INT/EXT switch 6 is in the EXT position.
- 6 **FREQ STANDARD INT/EXT switch:** normally left in the INT position. Removes power from internal frequency standard when in the EXT position.
- 7 **Jumper (A3W3):** normally connects the Internal Frequency Standard Output (A3J9) to the External Frequency Standard Input (A3J10).
- 8 **FREQ STANDARD Input (A3J10):** normally connected by A3W3 to A3J9. Also used to connect an external frequency standard of 5 or 10 MHz at 0 dBm to the Synthesizer.
- 9 **Line Power Module:** permits operation from 100, 120, 220, or 240 Vac. The number visible in the window displays the nominal line (Mains) voltage for which the Synthesizer is set (see Figure 2-1). The protective grounding conductor connects to the Synthesizer through this module. The line power fuse (A3F1) is part of this module and is the only part to be changed by the operator.

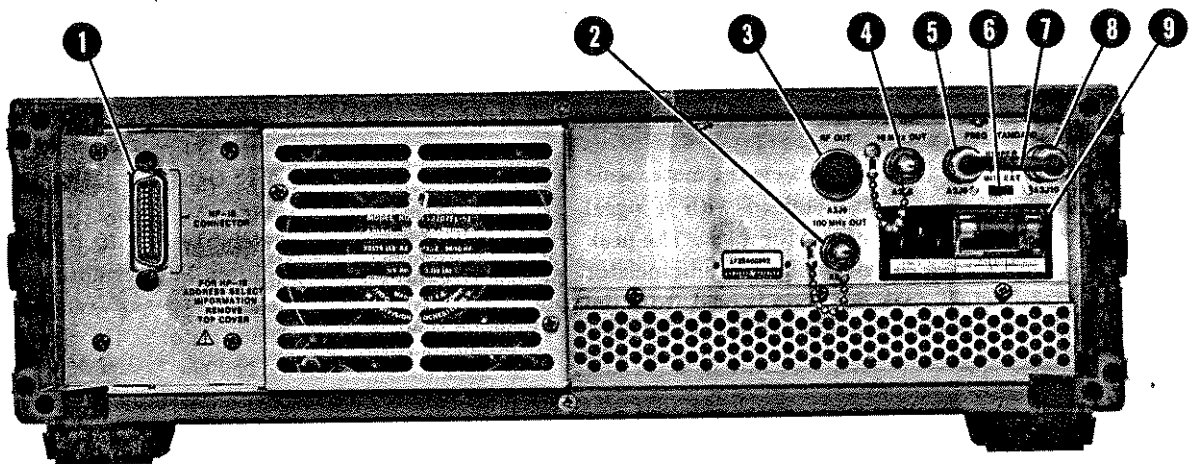

Figure 3-2. Rear Panel Connectors, Switches, and Displays

Table 3-3. Local Operator's Checks (1 of 4)

**INITIAL CONDITIONS**

1. Check that the LINE switch **12** is in STANDBY and remove the power cable from the Line Power Module **9** (see Figure 3-2).
2. Check that Line Power Module **9** (see Figure 3-2) is set to the nominal line voltage to be used and that the fuse is the correct value and type.
3. Set the front panel controls and switches as follows:

<b>15</b> AM selector	OFF
<b>17</b> ALC selector	INT
<b>18</b> FM DEVIATION MHz selector	OFF
<b>20</b> OUTPUT LEVEL VERNIER control	fully ccw
<b>24</b> OUTPUT LEVEL RANGE control	fully ccw
<b>25</b> PEAK-NORM switch	NORM (detented)
<b>27</b> RF switch	OFF
<b>28</b> METER MODE selector	LEVEL

4. Set the rear panel controls and cables as follows:

<b>6</b> FREQ STANDARD INT/EXT switch	INT
<b>7</b> Jumper (A3W3)	Connects A3J9 to A3J10

**OPERATION**

1. Set the LINE switch **9** to ON and check for the following conditions:
 

<b>1</b> RANGE dBm display	-110 dBm
<b>3</b> RF annunciator	OFF
<b>4</b> ALC annunciator	INT and LEV UNCAL
<b>5</b> AM annunciator	OFF
<b>6</b> FM annunciator	OFF
<b>7</b> FREQUENCY MHz display	some frequency between 2-18.6 GHz (if frequency display is not stable, press PRESET (3 GHz) <b>11</b> key.
<b>8</b> Frequency Resolution Light Bars	extinguished
<b>9</b> STATUS annunciators	
OVEN	may be lit and will extinguish when the reference oscillator oven operating temperature is reached.
NOT PHASE LOCKED	illuminated and will generally extinguish when the reference oscillator has warmed up before the OVEN light extinguishes.
2. Press PRESET (3 GHz) key **11** and FREQUENCY display **7** should now indicate 3000.000 MHz.

Table 3-3. Local Operator's Checks (2 of 4)

OPERATION (Cont'd)

3. Press one at a time, the four FREQUENCY RESOLUTION keys **13**; the Frequency Resolution Light Bars **8** should light one at a time and remain lit. Rotate the TUNING control **14** clockwise and then counter-clockwise and note that the digits displayed in the FREQUENCY display **8** increase and then decrease in order as the TUNING control **14** is turned. Perform this step as each of the four FREQUENCY RESOLUTION keys **13** are pressed. The first key on the left produces resolution in 100 MHz steps, the second key 1 MHz steps, the third key 10 kHz steps, and the fourth key 1 kHz, 2 kHz, or 3 kHz steps, depending upon the frequency band. Pressing the fourth key first will cause all four of the Frequency Light Bars **8** to light. Pressing the HOLD **10** pushbutton causes the Light Bars **8** to extinguish and prevents the TUNING control **14** from changing the frequency displayed.
4. Connect a microwave frequency counter to the Synthesizer as shown in Figure 3-3.
5. Set the RF switch **27** to ON. The ALC Block **4** annunciator LEV UNCAL should extinguish. If the STATUS Block **9** annunciator OVEN is extinguished, the NOT PHASE LOCKED annunciator should also extinguish. The Meter **2** should indicate -10 dB.

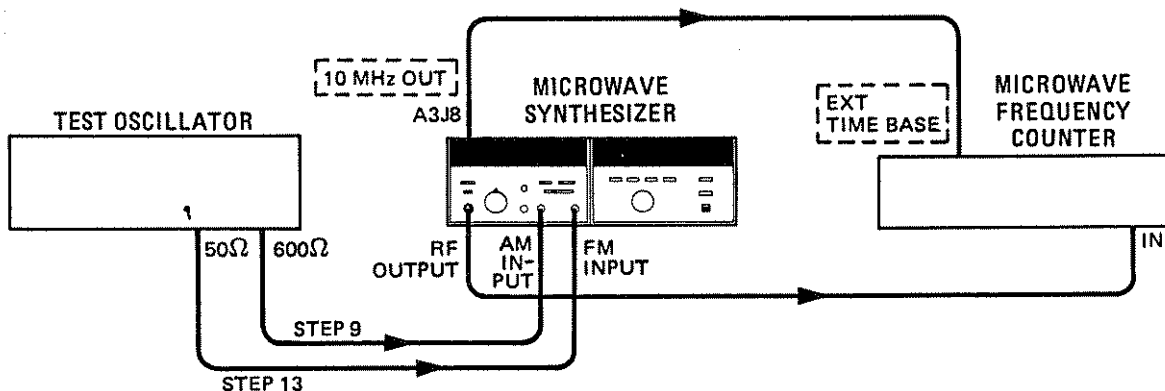

Figure 3-3. Operator's Frequency and Modulation Checks Test Setup

6. Turn the OUTPUT LEVEL RANGE control **24** clockwise through each of the thirteen positions (-110 to +10 dBm). At the 0 and +10 dBm positions and any other positions of interest, vary the OUTPUT LEVEL VERNIER control **20** from -10 to +3 dB. In the +10 dBm range, the VERNIER's range is specified only to +3 dBm output level but some Synthesizers may deliver more power. The RF Block **3** annunciator OVER RANGE lights when the +10 dBm range is selected. If the desired power cannot be produced, the ALC Block **4** annunciator LEV UNCAL is illuminated.

Table 3-3. Local Operator's Checks (3 of 4)

## OPERATION (Cont'd)

7. Note the frequency on the FREQUENCY MHz display **7**. Set the LINE switch **12** to the STANDBY position. The STATUS Block **9** annunciator STANDBY should light. Leave the Synthesizer in the standby condition for several seconds.
8. Set the LINE switch **12** to ON. The FREQUENCY MHz display **7** should display the same frequency as was displayed in step 7. The STATUS Block **9** annunciator STANDBY should extinguish.
9. Apply power to the test oscillator, set the frequency to 10 kHz and the output level to 0 Vrms. Connect the test setup as shown in Figure 3-3.
10. Set the METER MODE selector **28** to AM and the AM selector **15** to 100%. The AM annunciator **5** 100% should be lit.
11. Increase the output of the test oscillator slowly from 0.0 to approximately 0.8 Vrms. As the Meter **2** approaches full scale, the ALC Block **4** annunciator LEV UNCAL should illuminate. The LEV UNCAL annunciator is being used in this test as a modulation indicator. Normally having this annunciator illuminate indicates excessive modulation.
12. Set the AM selector **15** to OFF, reduce the test oscillator's output to 0 Vrms, and remove the cable from the AM INPUT connector **19**.
13. Set the test oscillator's frequency to 100 kHz.
14. Set the METER MODE selector **28** to FM and the FM DEVIATION MHz selector **18** to 3. The FM annunciator **6** 3 will light.
15. Increase the test oscillator's output from 0 Vrms to approximately 0.5 Vrms. The FM annunciator **6** OVERMOD will light when there is excessive deviation or an input signal greater than 1 Vpk.
16. Disconnect the test setup.
17. Set the ALC selector **17** to INT, METER MODE selector **28** to LEVEL, and the OUTPUT LEVEL RANGE control **24** to -10 dBm shown in the RANGE dBm display **1**. Adjust the OUTPUT LEVEL VERNIER control **20** for 0 dB on the Meter **2**. This will develop a -10 dBm level at the RF OUTPUT connector **26**.

Table 3-3. Local Operator's Checks (4 of 4)

**OPERATION (Cont'd)**

19. Set the RF switch 27 to ON. Adjust the CAL control 23 for a steady indication of the Meter 2. This adjusts the loop gain and prevents unwanted oscillations. The ALC Block 2 annunciator LEV UNCAL lights when oscillations occur or the loop opens, causing unleveling to occur.
20. Set the RF switch 27 to OFF. Disconnect the power meter and power sensor.
21. Connect a crystal detector as shown in Figure 3-4. Set the ALC selector 17 to XTAL.

**NOTE**

*The output voltage from the crystal detector may be either negative or positive polarity.*

22. Set the RF switch 27 to ON and adjust the CAL control 23 for a steady indication on the Meter 2.
23. Set the RF switch 27 to OFF. Disconnect the test setup.

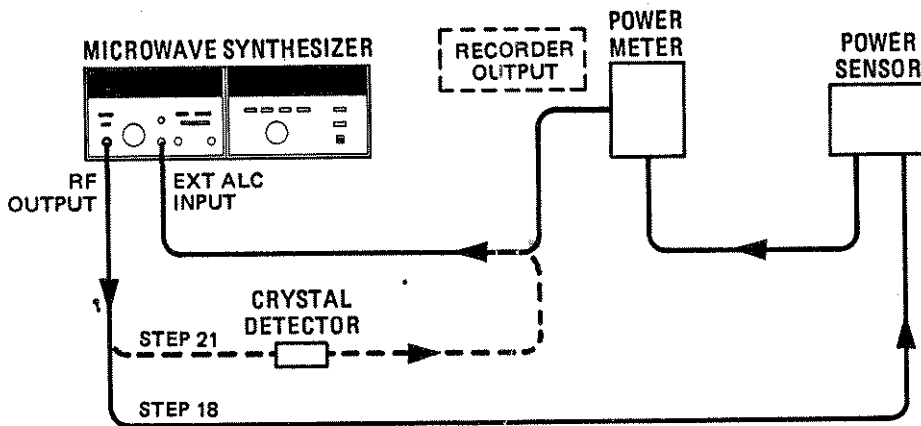

Figure 3-4. Operator's External ALC Checks Test Setup



Table 3-4. Local Operating Instructions (1 of 4)

**SETTING FREQUENCY AND OUTPUT LEVEL**

1. Be sure the Synthesizer is set to local. Make sure the internal reference is selected or an external reference is connected to A3J10.

2. Set front panel controls and switches to the following positions:

- 12 LINE switch . . . . . ON
- 13 FREQUENCY RESOLUTION keys . . . to resolution desired and displayed on Frequency Resolution Light Bars 8
- 14 TUNING control . . . . . to frequency desired as displayed on Frequency readout 7
- 10 HOLD pushbutton . . . . . press pushbutton, the frequency desired is not held
- 24 OUTPUT LEVEL RANGE control . . . . 00 on RANGE dBm display 1
- 27 RF switch . . . . . ON
- 20 OUTPUT LEVEL VERNIER control . . . . 0 dB on Meter 2

This sets a power level of 0 dBm at the RF OUTPUT connector 26.

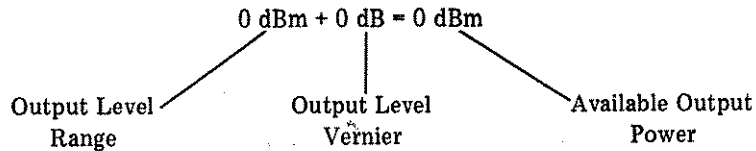

3. Set the OUTPUT LEVEL RANGE control 24 to indicate -10 dBm in the RANGE dBm display 1. Adjust the OUTPUT LEVEL VERNIER control 20 to indicate -5 dB on the Meter 2. This sets an output power level of -15 dBm at the RF OUTPUT connector 26.

$$-10 \text{ dBm} + (-5 \text{ dB}) = -15 \text{ dBm}$$

The indication on the Meter 2 plus the reading on the RANGE dBm display 1 equals the power level at the RF OUTPUT connector 26.

**Table 3-4. Local Operating Instructions (2 of 4)**

**USING AN EXTERNAL STANDARD**

1. On the rear panel (see Figure 3-2), remove Jumper **7** (A3W3) from the FREQ STANDARD EXT connector **8** (A3J10), and set the FREQ STANDARD INT/EXT switch **6** to EXT.
2. Connect an external frequency standard of 5 or 10 MHz, 0 dBm (nominal) into 50 ohms impedance to the FREQ STANDARD EXT connector **8**.
3. Set the LINE **12** switch to ON and the RF switch **27** to ON.
4. The front panel display should indicate as follows:  
 STATUS annunciator. . . . . INTERNAL REF OFF  
 The NOT PHASE LOCKED annunciator may light if the external reference is not of sufficient accuracy in frequency or has an insufficient power level. The external reference must be within  $\pm 200$  Hz of 10 MHz or  $\pm 100$  Hz of 5 MHz for reliable locking to occur.
5. The Synthesizer may now be used for any of its normal operations.

**SETTING AMPLITUDE MODULATION**

1. Set front panel (see Figure 3-1) controls and switches as follows:  
**28** METER MODE selector . . . . . AM
2. Connect an oscillator with a 600 ohm output impedance to the AM INPUT connector **19**. Set the oscillator's output to 0 Vrms and to the modulation frequency desired.
3. Set the AM Function switch **15** to 30% or 100%. The Meter **2** should indicate 0% on the 0 to 3 scale, or 0% on the 0 to 10 scale.
4. Set the OUTPUT LEVEL VERNIER control **20** and the OUTPUT LEVEL RANGE control **24** to the level desired from the RF OUTPUT connector **26**. The OUTPUT LEVEL VERNIER **20** control should be set to 0 dB or below for least distortion.
5. Increase the oscillator's output until the desired percent modulation between 0 to 30% (full scale) is reached. Full scale is 1 Vpk.

Table 3-4. Local Operating Instructions (3 of 4)

**SETTING FREQUENCY MODULATION**

1. Set front panel (see Figure 3-1) controls and switches as follows:
  - 28 METER MODE selector . . . . . FM
2. Connect a modulation source with a 50 ohm output impedance to the FM INPUT connector 16. Set the oscillator's output to 0 Vrms and to the modulation frequency desired.
3. Set the FM DEVIATION MHz selector 18 to the desired deviation range. The peak deviation is shown on the Meter 2. The 0.03, 0.3, and 3 ranges are indicated on the Meter 2 on the 0 to 3 scale and the 0.1, 1, and 10 ranges are indicated on the 0 to 1.0 scale.
4. An FM input of 1.0 Vpk (0.707 Vrms) represents full scale modulation. Set the input level to obtain the desired deviation within the specified modulation index and deviation limits.
5. The FM annunciator 6 OVERMOD will light to indicate that an over modulation condition exists. This can occur if an input signal of greater than 1 Vpk is applied or if the maximum allowable modulation index is exceeded. The STATUS BLOCK 9 annunciator NOT PHASE LOCKED may also illuminate under conditions of excessive deviation.

**SETTING EXTERNAL ALC WITH A POWER METER OR CRYSTAL DETECTOR**

1. Set front panel (see Figure 3-1) controls and switches as follows:
  - 25 PEAK-NORM control . . . . . NORM (detented)
  - 27 RF switch . . . . . ON
  - 28 Meter Mode selector . . . . . LEVEL
2. Set the LINE switch 12 to ON and set the OUTPUT LEVEL VERNIER control 20 and the OUTPUT LEVEL RANGE control 24 for -10 dBm output.
3. Connect the external leveling crystal detector (XTAL) or a power meter (PWR MTR) to sense the RF signal level at the point to be leveled. The leveling device may produce either a positive or negative polarity output voltage. The Synthesizer automatically produces the proper polarity signal to use with the ALC loop.
  - 4a. If using a crystal detector, connect the detectors output to the EXT ALC INPUT connector 21. Set the ALC selector 17 to XTAL.
  - 4b. If using a power meter, connect the Recorder Output to the EXT ALC INPUT connector 17. Set the ALC selector 21 to PWR MTR.

Table 3-4. Local Operating Instructions (4 of 4)

## SETTING EXTERNAL ALC WITH A POWER METER OR CRYSTAL DETECTOR (Cont'd)

## NOTE

*If the HP 436A Power Meter is to be used, set the Synthesizer's output level to  $-1$  dBm with the ALC selector 17 set to INT. Depress the RANGE HOLD pushbutton on the 436A. If the RANGE HOLD pushbutton is not depressed, the power meter may slowly oscillate due to autoranging.*

5. Set the OUTPUT LEVEL RANGE control 24 and the VERNIER control 20 for the desired power level.
6. Adjust the CAL control 23 to obtain a stable, leveled power output 10 dB below the output level indicated by the RANGE dBm display 1 and the indication on the Meter 2. The 10 dB offset places the ALC loop in the center of its dynamic range.

### 3-16. REMOTE (HP-IB) OPERATION

3-17. The Synthesizer can be operated through the Hewlett-Packard Interface Bus (HP-IB). For further information about the HP-IB, refer to IEEE Standard 488-1975, the Hewlett-Packard catalog, and the booklet "Improving Measurements in Engineering and Manufacturing" (HP Part No. 5952-0058). Synthesizer compatibility, programming, and data format is described in the paragraphs which follow.

3-18. Synthesizer Talk and Listen address, and Parallel and Serial Poll response selection is described in Section II.

3-19. For Synthesizer remote checkout and troubleshooting, refer to the Remote Operator's Check and the HP-IB Diagnostic Program in Section VIII. The Remote Operator's Check verifies that the Synthesizer's functions can be programmed while the HP-IB Diagnostic Program tests the Bus functions of the Synthesizer.

### 3-20. Compatibility

3-21. The Synthesizer is fully programmable with the HP-IB. Front panel functions except the LINE switch **12**, (see Figure 3-1). METER MODE selector **28**, PEAK-NORMAL control **25**, and CAL control **23** can be programmed.

3-22. The programming capability of the Synthesizer will be described in terms of the twelve bus messages found in Table 3-5.

### 3-23. Local/Remote and Remote/Local Mode Changes

3-24. The Synthesizer can communicate over the bus when in remote or local. In remote, the Synthesizer's front panel controls are disabled and the Synthesizer can be addressed to talk or listen. When addressed to listen, the Synthesizer will respond to the Data, Clear (SDC), Local, and Clear Lockout/Set Local. When addressed to talk, the Synthesizer automatically stops listening and sends a status byte over the eight data lines. Also, the Synthesizer can send a service request (SRQ) and respond to serial and parallel polls and the Abort message. In local, the Synthesizer is fully controlled by the front panel, but it will respond to serial or parallel polls, its talk address, and it will send a service request (SRQ).

3-25. Addressing. The Synthesizer interprets the byte on the bus' eight data lines as an ASCII ad-

dress or command if the remote enable line (REN) is true and the bus is in the command mode: attention line (ATN) true and interface clear line (IFC) false. The Synthesizer's talk and listen addresses are switch selectable as described in Section II. Referring to Table 2-1, characters in columns 2 or 3 are valid listen addresses, characters in columns 4 and 5 are talk addresses, and characters in column 1 are commands: device clear (DC), serial poll enable (SPE), and serial poll disable (SPD).

3-26. Programming the Local to Remote Mode Change. The Synthesizer will switch to remote only when addressed to listen. When first switched to remote, the REMOTE lamp lights and the VERNIER resets to -10 dB. Nothing else will change from the front panel control settings until the Synthesizer receives a data message string. Once in remote, the synthesizer can be addressed to talk, re-addressed to listen, programmed to return to local, or unaddressed with the universal Unlisten address or Abort message.

3-27. Programming the Remote to Local Mode Change. The Synthesizer will return to local when the Local or Clear Lockout/Set Local messages are sent by the controller. The Clear Lockout/Set Local message sets the remote enable line (REN) false.

### 3-28. Data Messages

3-29. The Synthesizer communicates on the bus primarily with data messages. It responds to data messages that program frequency, output level, modulation and ALC configuration. It sends a byte that describes its status. Data messages consist of one or more bytes sent over the bus' 8 data lines when the bus is in the data mode (attention line [ATN] false). The Synthesizer receives data messages when addressed to listen and sends a status byte when addressed to talk.

### 3-30. Receiving Data Messages

3-31. The Synthesizer can receive Data messages when addressed to listen. The Data message string, or program string, consists of one or more ASCII characters, arranged as a program code followed by arguments. The codes and arguments for a given function need not be on the same program line.

3-32. Data Input Format. The program string syntax is as shown in Example 1. For example, to program the four functions for 12.596365 GHz, -94 dBm AM and FM OFF, and ALC internal normal, use the program codes and arguments in Table 3-10 and write the string as in Example 2.

Table 3-5. Message Reference Table

Message and Identification	Applicable	Command and Title	Response
Data	Yes	T6 Talker, L4 Listener, AH1 Acceptor Handshake SH1 Source Handshake	Synthesizer can change frequency, output level, modulation, and ALC. Sends status byte when addressed to talk.
Trigger (DT0)	No	Device Trigger	Synthesizer does not respond to a Device Trigger.
Clear (DC1)	Yes	DCL Device Clear	The Synthesizer responds to a DCL or SDC command by setting frequency to 3 GHz, Modulation to off, RF off, and ALC to Internal.
	Yes	SDC Selected Device Clear	
Remote (RL2)	Yes	REN Remote Enable	Synthesizer goes to remote when the REN line is true and the Synthesizer is first addressed to listen.
Local (RL2)	Yes	GTL Go to Local	Synthesizer goes to local when a GTL command is received. The frequency does not change but the front panel controls determine the other functions.
Local Lockout (RL2)	No	LLO Local Lockout	Synthesizer does not respond to the LLO command.
Clear Lockout/ Set Local (RL2)	Yes	REN Remote Disable	Synthesizer goes to local when REN goes false.
Pass Control/ Take Control (C0)	No	Controller	The Synthesizer cannot act as a controller.
Require Service (SR1)	Yes	SRQ Service Request	The Synthesizer sets SRQ line true when when unlocked, unlevelled, FM overmodulated or out of range (freq.).
Status Byte	Yes	SPE Serial Poll Enable	The Synthesizer responds to a serial poll by sending a status byte.
	Yes	SPD Serial Poll Disable	
Status Bit (PP2)	Yes	PP Parallel Poll	The Synthesizer responds to a parallel poll by sending a status bit on a switch selected data line.
Abort	Yes	IFC Interface Clear	The synthesizer stops listening or talking.

## NOTE

Complete HP-IB capability as defined in IEEE Std. 488 is DC1, RL2, SR1, PP2, T6, L4, AH1, SH1, DT0, C0.

Receiving Data Messages (Cont'd)

EXAMPLE 1

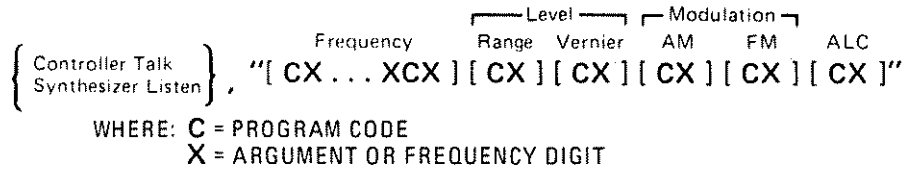

EXAMPLE 2

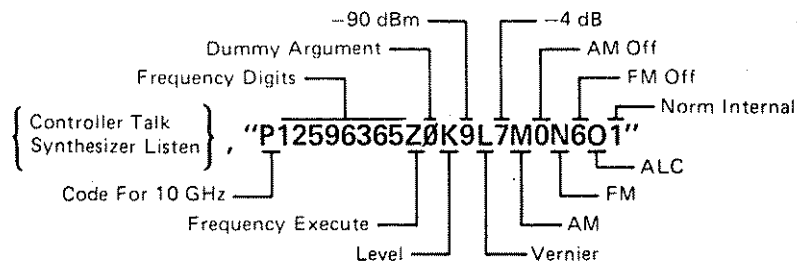

The Synthesizer ignores spaces, commas, decimal points, carriage returns, and line feeds. Paragraph 3-37 has more information on program codes. All functions may be programmed together as shown or separately as will be described in detail in the following paragraphs.

**3-33. Programming Frequency.** The Synthesizer accepts any frequency within its range to 8 significant digits. Above 6.2 GHz the 1 kHz digit is rounded up or down to be compatible with the 2 kHz or 3 kHz resolution. Use Figure 3-5 and Table 3-6 to write the program string with the following syntax:

Table 3-6. Frequency Program Codes and Arguments

	Program Codes		Arguments
FREQUENCY	10 GHz	P	Ø THROUGH 9
	1 GHz	Q	
	1 MHz	T	
	100 kHz	U	
	10 kHz	V	
	1 kHz	W	
	EXECUTE	Z	

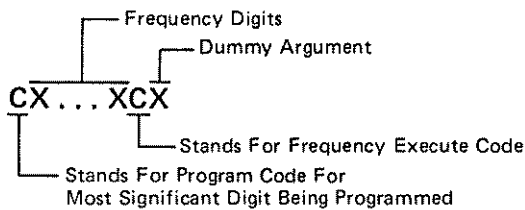

Within the Synthesizer, frequency information is stored in two blocks of four digits each. One block is for the 10 GHz through 10 MHz digits; the other block is for the 1 MHz through 1 kHz digits. Programming within one block does not change the other block unless it is necessary for the Synthesizer to round off the 1 kHz digit for frequencies above 6.2 GHz. Figure 3-5 illustrates this; use it as a guide to make Frequency programming easier.

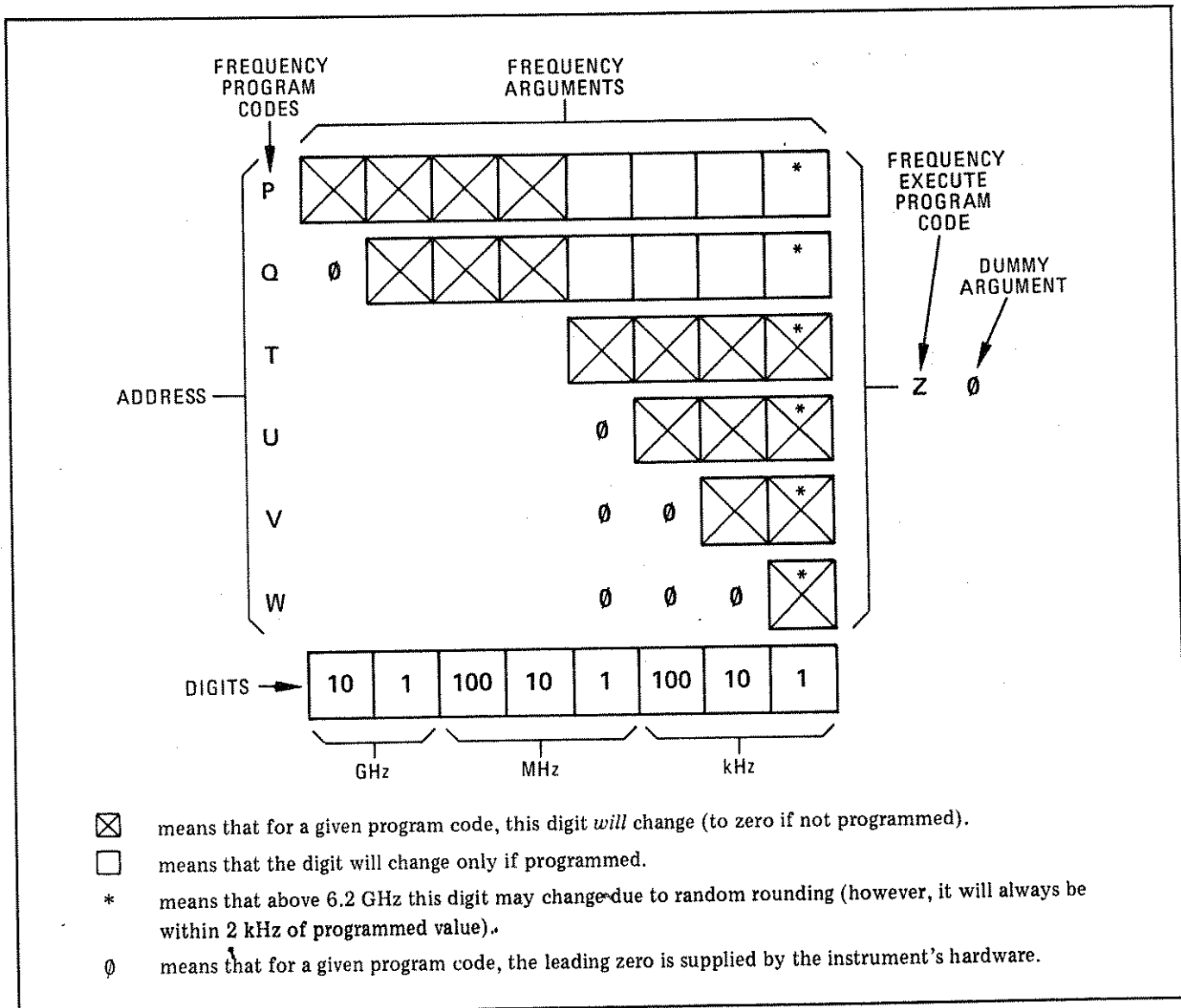
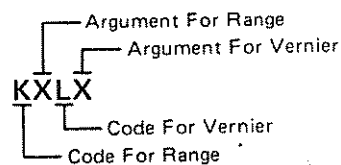

Figure 3-5. Frequency Programming

Receiving Data Messages (Cont'd)

3-34. Programming Output Level. The 0 to -110 dBm positions of the Synthesizer's RANGE switch, and the Functions of the VERNIER control are programmed with the output level string. The VERNIER control's function is programmed in 1 dB steps from +3 to -10 dB. RANGE is programmed in 10 dB steps, and the +10 dB position (over-range) of the RANGE switch is programmed with the ALC code and argument (see paragraph 3-36). Although it is possible to program the +10 dB range with 10 dB step attenuation (RANGE) it is unnecessary and should not be done<sup>1</sup>. The output level program string consists of the program codes for RANGE and VERNIER each followed by an argument (Table 3-7) as shown.



<sup>1</sup> For the Synthesizer to achieve a +10 dBm output level, the RANGE and VERNIER arguments must be set for 0 dBm.

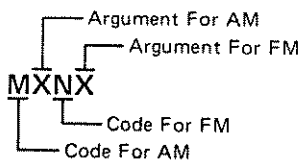

Table 3-7. Output Level

	Program Codes	Arguments
Output Level Range	K	0 dBm 0
		-10 1
		-20 2
		-30 3
		-40 4
		-50 5
		-60 6
		-70 7
		-80 8
		-90 9
		-100 :
-110 ;		
Output Level Vernier	L	+3 dB 0
		+2 1
		+1 2
		0 3
		-1 4
		-2 5
		-3 6
		-4 7
		-5 8
		-6 9
		-7 :
-8 ;		
-9 <		
-10 =		

Receiving Data Messages (Cont'd)

3-35. Programming Modulation. The Synthesizer accepts codes and arguments (Table 3-8) for two ranges of AM and six ranges of FM. The two modulation types can be used separately or together. Program string syntax is as follows:



3-36. Programming ALC. The ALC program string controls the functions of the RF ON-OFF switch, the ALC selector switch, and the +10 dBm position of the output level RANGE switch. The string consists of the program code, which is O (the letter O), followed by a single argument representing the desired combination of the switch positions. Each switch position has a numerical weight. Compute the argument by adding the weights (use the equal sign [=] for a weight of 13, and the question mark [?] for a weight of 17).

Table 3-8. Modulation

	Program Codes	Arguments
AM	M	OFF 0 or 1
		100% 2
		30% 3
FM	N	OFF 6 or 7
		30 kHz 5
		100 kHz 4
		300 kHz 3
		1 MHz 2
		3 MHz 1
10 MHz 0		

Weighting is as follows:

RF ON-OFF switch; ALC switch; RANGE switch;  
 OFF = 0 INT = 0 0 dBm = 0  
 ON = 1 XTAL = 4 +10 dBm = 2  
 MTR = 12

Note that for the Synthesizer to achieve a +10 dBm RF output level, the output level RANGE and VERNIER arguments must be set for 0 dBm and the ALC argument must be appropriate for +10 dBm output. With RF OFF, combinations of the other two switches results in arguments of 0, 2, 4, 6, or 8. For RF ON, possible arguments are in the following table:

Table 3-9. ALC Arguments (with RF ON)

	RANGE switch	0 dBm	+10 dBm
ALC switch			
INT		1	3
XTAL		5	7
MTR		=	?

In general, an even argument results in the RF ON-OFF switch being set OFF, while an odd argument results in RF ON with the other switch combinations as shown in the table.

3-37. Optional Program Codes. The Synthesizer interprets any ASCII character in columns 4 and 5 of Table 2-1 as a program code. The two columns are equivalent; for example, it will respond the same way to "Z" as it does to "J". The Synthesizer ignores all other characters.

3-38. Abbreviated Program String. The Synthesizer accepts and processes the characters of a pro-

**Receiving Data Messages (Cont'd)**

gram string in a left to right sequence. It also automatically counts program codes in the sequence shown in Table 2-1 columns 4 and 5. This sequence is equivalent to the program string order shown in paragraph 3-32. If done in that sequence, program strings for level, modulation, and ALC can be written like those for frequency. The program string will consist of the program code for the first function being programmed followed by arguments for all functions as shown below:

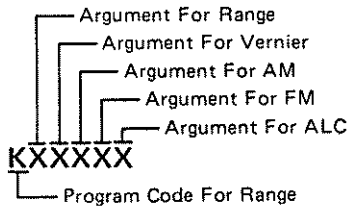

**3-39. Programming Execution Time.** Programming execution time is determined by two parameters: the rate at which data can be input into the Synthesizer over the interface and the time it takes the Synthesizer to reach the desired output state. The Synthesizer can typically accept data at rates up to 80 kbytes/second. This is generally a much shorter time than it then takes the Synthesizer to reach the desired output state. If the controller and all other instruments on the bus are fast enough, data transfer is then only a small fraction of the total program execution time. Typical execution times for the various functions of the Synthesizer are as follows:

**a. Frequency Switching.** The time it takes to switch from one frequency to the next depends on the largest frequency digit being changed. Generally, the smaller the digit being changed, the shorter the switching time. Typical switching times by largest digit being changed on the 2.0 to 6.2 GHz band are shown in Figure 3-6 below. For higher bands, actual digits being changed must be determined by dividing the output frequency by 2 (6.2 to 12.4 GHz band), or by 3 (12.4 to 18 GHz band). If FM is on during a frequency change, switching time will increase.

Largest Digit Changed	100 MHz	10 MHz	1 MHz	100 kHz	10 kHz	1 kHz
Time to be Within 1 kHz	10 ms	10 ms	10 ms	5 ms	3 ms	1.5 ms

**b. Output Level Programming**

- Output range switching (10 dB steps) . . . . . <20 ms
- Output vernier switching (1 dB steps) . . . . . <10 ms
- RF ON/OFF switch ON . . . . . <30 ms
- RF ON/OFF switch OFF . . . . . < 5 ms

**c. Modulation Programming**

- FM range change and frequency change in FM mode . . . . . <50 ms
- AM range change . . . . . <15 ms

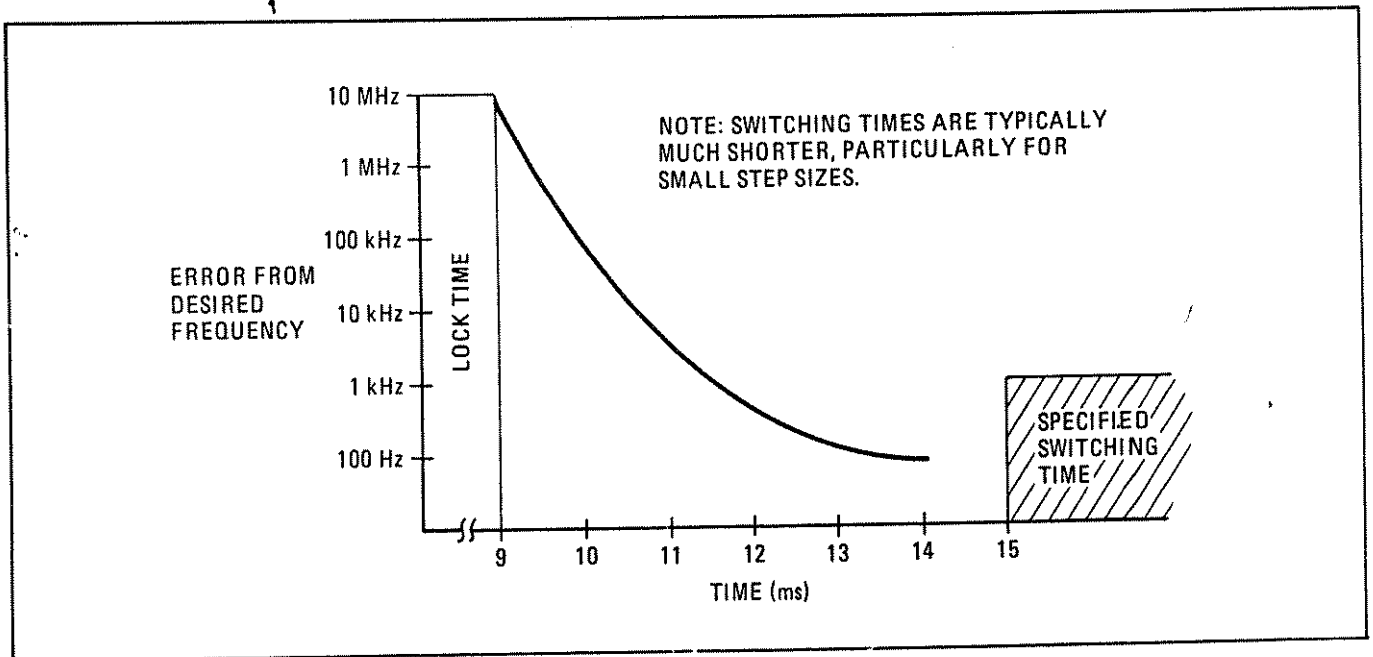

Figure 3-6. Typical frequency switching time showing WORST CASE lock and settling times

**3-40. Sending Data Messages**

3-41. The Synthesizer sends a status byte when addressed to talk. This byte is the Synthesizer's response to a serial poll which will be explained in paragraph 3-59. The Synthesizer will talk when in local as well as remote.

**3-42. Receiving the Trigger Message**

3-43. The Synthesizer doesn't respond to the Trigger message.

**3-44. Receiving the Clear Message**

3-45. The Synthesizer responds to the Clear message by setting the frequency to 3 GHz, ALC to internal, RF power off, and modulation off. This message can take two forms: Device Clear, which the Synthesizer responds to when not addressed, and Selected Device Clear which the Synthesizer responds to when addressed to listen. The Device Clear messages do not affect addressing.

**3-46. Receiving the Remote Message**

3-47. The Synthesizer is enabled to go into remote when the controller sends the Remote message, but does not actually switch to remote until first addressed to listen. The Remote message is the means by which the controller sets the remote enable line (REN) true. Some controllers send this message automatically when first turned on or reset.

**3-48. Receiving the Local Message**

3-49. The Synthesizer returns to local front panel control when it receives the Local message. The frequency will not change from the last programmed value but the other functions will correspond to the front panel control settings.

**3-50. Receiving the Local Lockout Message**

3-51. The Synthesizer does not respond to the Local Lockout message.

**3-52. Receiving the Clear Lockout/Set Local Message**

3-53. The Synthesizer responds to the Clear Lockout/Set Local message in the same way as to the Local message (that is, it returns to local). The Synthesizer need not be addressed to listen. This message sets the REN line false.

**3-54. Receiving the Pass Control Message**

3-55. The Synthesizer does not respond to the Pass Control message as it cannot act as a controller.

**3-56. Sending the Require Service Message**

3-57. The Synthesizer sends the Require Service message to the controller when one of the following conditions exists for more than 50 ms:

- 1) Not phase-locked with RF power on.
- 2) Frequency programmed out of range.
- 3) RF power level uncalibrated with RF power on.
- 4) FM overmodulated with RF power on.

The Synthesizer sends this message by setting the service request line (SRQ) true. It will request service in local or remote whether or not it is addressed.

**3-58. Sending the Status Byte Message**

3-59. The Synthesizer sends the status byte when addressed to talk. This byte is the Synthesizer's response to a serial poll. The Synthesizer responds to a serial poll when the controller sends a serial poll enable command (SPE), then addresses the Synthesizer to talk. The SPE command enables the Synthesizer to clear the service request (SRQ) when addressed to talk. Also, when the Synthesizer receives its talk address, bit 7 of the status byte is latched. The Controller can then determine the status of the Synthesizer by converting the status byte to a decimal value. Status byte coding is as follows:

**STATUS BYTE**

Bit Number	8	7	6	5	4	3	2	1
Decimal Value	128	64	32	16	8	4	2	1
Function	CRYSTAL OVEN COLD	RSV REQUEST SERVICE	OUT OF RANGE (frequency)	RF OFF	NOT PHASE LOCKED	LEV UNCAL	FM OVER- MOD	+10 dBm OVER- RANGE

**Sending the Status Byte Message (Cont'd)**

3-60. The RSV (Request Service) bit is true whenever any of the four conditions that cause a request for service exists (even during the first 50 ms after a programming change). Once the Synthesizer is addressed to talk, the RSV line is latched even though the Synthesizer's need for service may have changed.

3-61. The status byte is useful for determining when a given programming change has been executed. For example, if the Synthesizer is addressed to talk immediately after a frequency change, the status byte can be used to determine when the Synthesizer has re-acquired lock. A frequency change might be followed by a status byte sequence of 72, 72, and then 64, indicating the Synthesizer is now locked.

**3-62. Sending the Status Bit Message**

3-63. The Synthesizer outputs a status bit on one of the Bus data lines in response to a parallel/poll

(see controller manual). The line is switch selectable (see Section II) as is the level of the bit's logic. The status bit represents the RSV bit of the status byte.

**3-64. Receiving the Abort Message**

3-65. The Synthesizer stops talking or listening when it receives the Abort Message.

**3-66. Programming Quick Reference Guide**

3-67. Table 3-10 shows program string syntax, program codes and arguments, and the status byte. All possible program codes (including equivalent duplicates) are shown, but the recommended codes are indicated with boldface type.

**3-68. Programming Examples**

3-69. Figure 3-7 is a flowchart showing how to program all of the Synthesizer functions and the twelve bus messages in HPL (9825 computing controller), and BASIC (9830 computing controller).

Table 3-10. Programming Quick Reference Guide

PROGRAM STRING SYNTAX

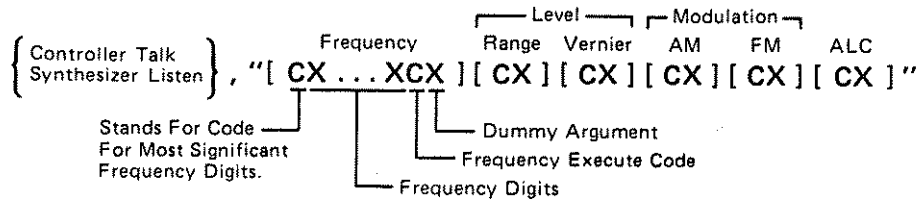

WHERE: C = PROGRAM CODE  
 X = ARGUMENT OR FREQUENCY DIGIT

	PROGRAM CODES	ARGUMENTS
FREQUENCY	10 GHz @ or P	Ø THROUGH 9
	1 GHz A or Q	
	100 MHz B or R	
	10 MHz C or S	
	1 MHz D or T	
	100 kHz E or U	
	10 kHz F or V	
	1 kHz G or W	
EXECUTE	J or Z	
FM	N or )	OFF 6 or 7
		30 kHz 5
		100 kHz 4
		300 kHz 3
		1 MHz 2
		3 MHz 1
		10 MHz Ø
ALC	0 or _	RF OFF 0,2,4,6,8
		INT NORMAL 1
		INT,+10 RANGE 3
		XTAL,NORMAL 5
		XTAL,+10 RANGE 7
		MTR,NORMAL =
MTR,+10 RANGE ?		

	PROGRAM CODES	ARGUMENTS
OUTPUT LEVEL RANGE	K or [	0 dBm 0
		-10 1
		-20 2
		-30 3
		-40 4
		-50 5
		-60 6
		-70 7
		-80 8
		-90 9
-100 :		
-110 ;		
OUTPUT LEVEL VERNIER	L or \	+3 dB 0
		+2 1
		+1 2
		0 3
		-1 4
		-2 5
		-3 6
		-4 7
		-5 8
		-6 9
-7 :		
-8 ;		
-9 <		
-10 =		
AM	M or ]	OFF 0 or 1
		100% 2
		30% 3

STATUS BYTE

Bit Number	8	7	6	5	4	3	2	1
Decimal Value	128	64	32	16	8	4	2	1
Function	CRYSTAL OVEN COLD	RSV REQUEST SERVICE	OUT OF RANGE (frequency)	RF OFF	NOT PHASE LOCKED	LEV UNCAL	FM OVER-MOD	+10 dBm OVER RANGE

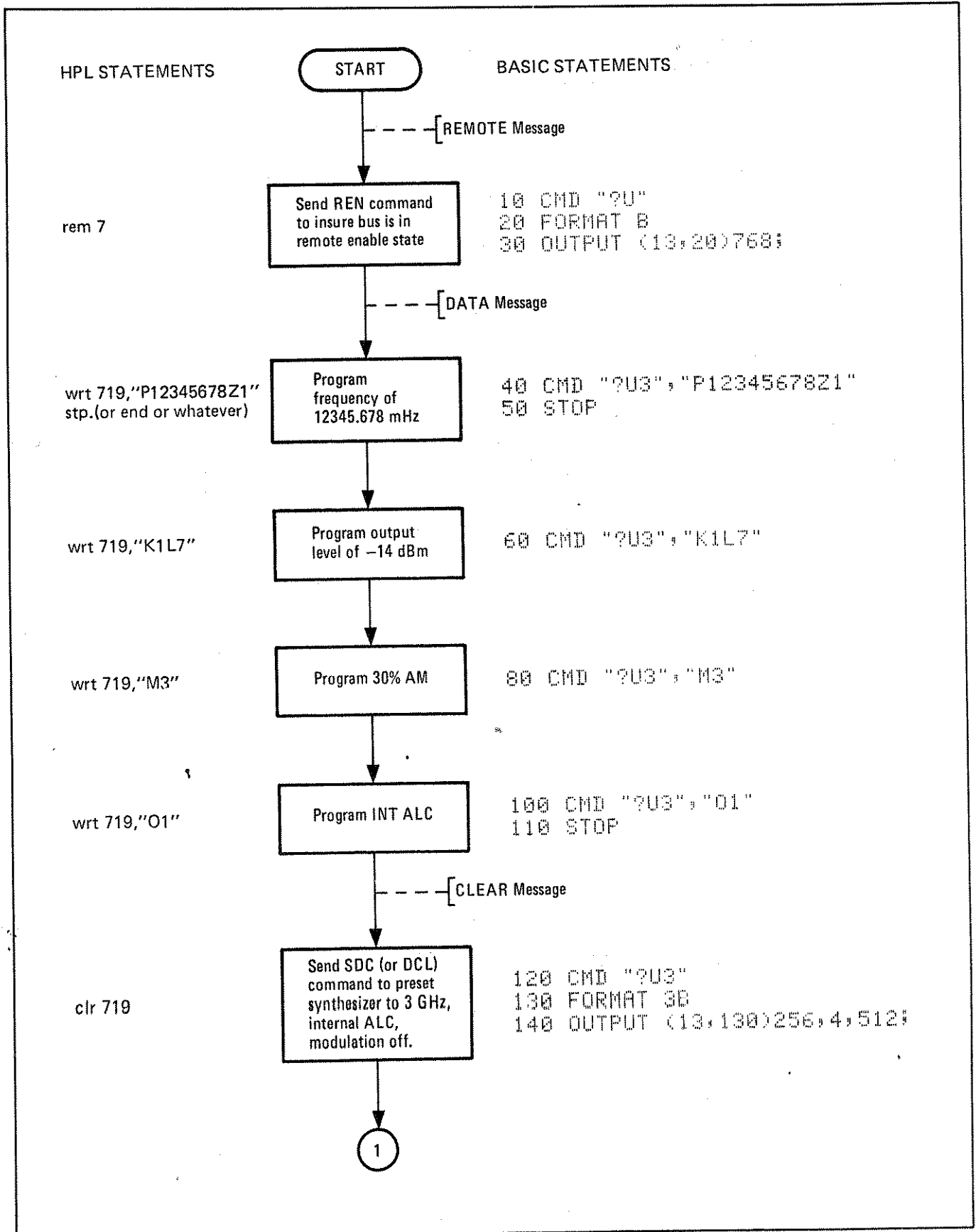

Figure 3-7. Programming Examples (1 of 2)

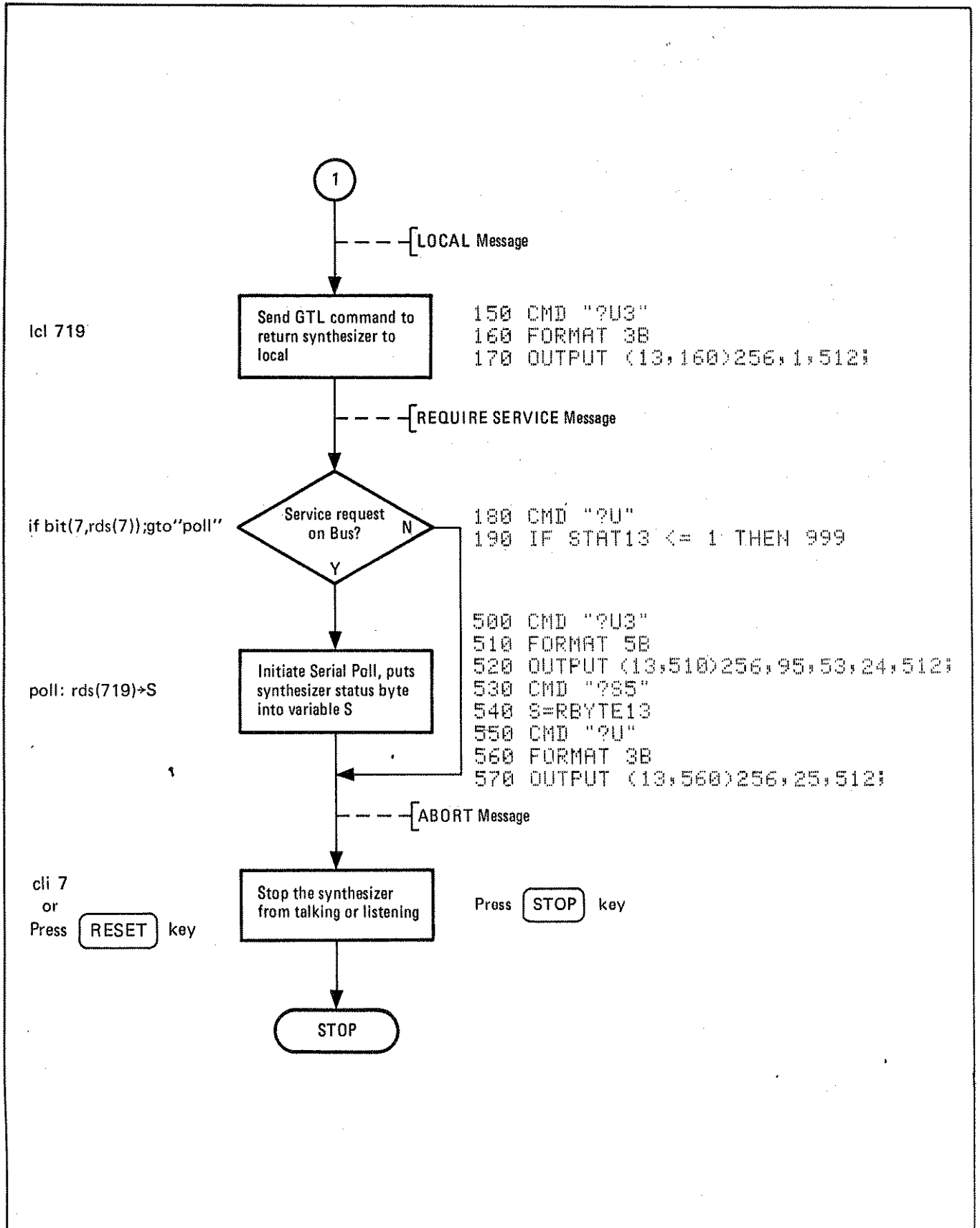

Figure 3-7. Programming Examples (2 of 2)

